

SLEEP mode is exited in one of two ways as shown below.

**RESET Exit from SLEEP mode.** If the  $\overline{\text{RESET}}$  input is held LOW for at least 6 clock cycles, it will exit SLEEP mode and begin the normal RESET sequence with execution starting at address (logical and physical) 00000H.

**Interrupt Exit from SLEEP mode.** The SLEEP mode is exited by detection of an external (NMI, INT0-INT2) or internal (ASCI, CSI/O, PRT) interrupt.

In case of  $\overline{\text{NMI}}$ , SLEEP Mode is exited and the CPU begins the normal  $\overline{\text{NMI}}$  interrupt response sequence.

In the case of all other interrupts, the interrupt response depends on the state of the global interrupt enable flag (IEF<sub>1</sub>) and the individual interrupt source enable bit.

If the individual interrupt condition is disabled by the corresponding enable bit, occurrence of that interrupt is ignored and the CPU remains in the SLEEP state.

Assuming the individual interrupt condition is enabled, the response to that interrupt depends on the global interrupt enable flag (IEF<sub>1</sub>). If interrupts are globally enabled (IEF<sub>1</sub>=1) and an individually enabled interrupt occurs, SLEEP mode is exited and the appropriate normal interrupt response sequence is executed.

If interrupts are globally disabled (IEF<sub>1</sub>=0) and an individually enabled interrupt occurs, SLEEP mode is exited and instruction execution begins with the instruction following the SLP instruction. Note that this provides a technique for synchronization with high speed external events without incurring the latency imposed by an interrupt response sequence.

Figure 10 shows SLEEP timing.

**IOSTOP mode.** IOSTOP mode is entered by setting the IOSTOP bit of the I/O Control Register (ICR) to 1. In this case, on-chip I/O (ASCI, CSI/O, PRT) stops operating. However, the CPU continues to operate. Recovery from IOSTOP mode is by resetting the IOSTOP bit in ICR to 0.

**SYSTEM STOP mode.** SYSTEM STOP mode is the combination of SLEEP and IOSTOP modes. SYSTEM STOP mode is entered by setting the IOSTOP bit in ICR to 1 followed by execution of the SLP instruction. In this mode, on-chip I/O and CPU stop operating, reducing power consumption. Recovery from SYSTEM STOP mode is the same as recovery from SLEEP mode, noting that internal I/O sources (disabled by IOSTOP) cannot generate a recovery interrupt.

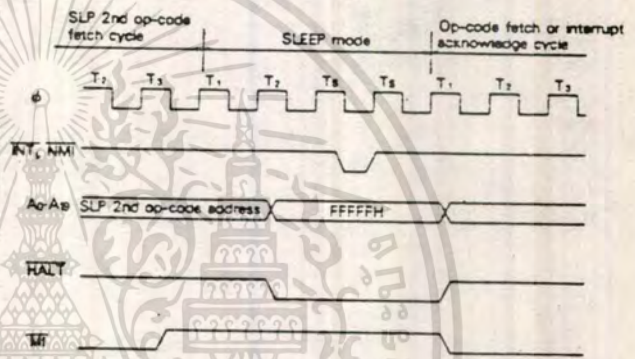

Figure 20. SLEEP Timing

## Internal I/O Registers

The Z80180 internal I/O Registers occupy 64 I/O addresses (including reserved addresses). These registers access the internal I/O modules (ASCI, CSI/O, PRT) and control functions (DMAC, DRAM refresh, interrupts, wait state generator, MMU and I/O relocation).

To avoid address conflicts with external I/O, the Z80180 internal I/O addresses can be relocated on 64 byte boundaries within the bottom 256 bytes of the 64K byte I/O address space.

**I/O Control Register (ICR).** ICR allows relocating of the internal I/O addresses. ICR also controls enabling/disabling of the IOSTOP mode.

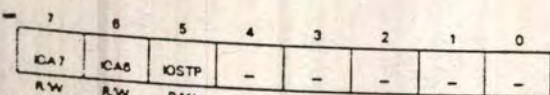

Figure 21 I/O Control Register (ICR : I/O Address = 3FH)

**IOA7, 6: I/O Address Relocation (bits 7, 6)**

IOA7 and IOA6 relocate internal I/O as shown in Fig. 22. Note that the high-order 8 bits of 16-bit internal I/O addresses are always 0. IOA7 and IOA6 are cleared to 0 during RESET.

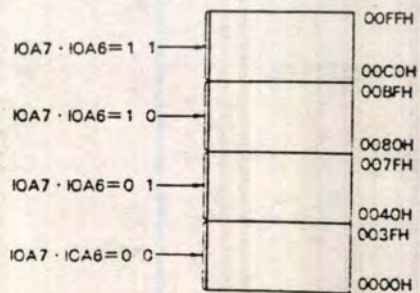

Figure 22. I/O Address Relocation

**IOSTP: IOSTOP Mode (bit 5)**

IOSTOP mode is enabled when IOSTP is set to 1. Normal

I/O operation resumes when IOSTP is reset to 0. IOSTP is cleared to 0 during RESET.

#### Internal I/O Registers Address Map

The internal I/O register addresses are shown in Table 4. These addresses are relative to the 64 byte boundary base address specified in ICR.

**I/O Addressing Notes.** The internal I/O register addresses are located in the I/O address space from 0000H to 00FFH (16-bit I/O addresses). Thus, to access the internal I/O registers (using I/O instructions), the high-order 8 bits of the 16-bit I/O address must be 0.

The conventional I/O instructions (OUT (m), A/ IN A, (m) / OUT1 / IN1/ etc.) place the contents of a CPU register on the high-order 8 bits of the address bus, and thus may be difficult to use for accessing internal I/O registers.

For efficient internal I/O register access, a number of new instructions have been added, which force the high-order 8 bits of the 16-bit I/O address to 0. These instructions are IN0, OUT0, OTIM, OTIMR, OTDM, OTDMR and TSTIO (see Instruction Set).

When writing to an internal I/O register, the same I/O write occurs on the external bus. However, the duplicate external I/O write cycle will exhibit internal I/O write cycle timing. For example, the WAIT input and programmable wait state generator are ignored. Similarly, internal I/O read cycles also cause a duplicate external I/O read cycle - however, the external read data is ignored by the Z80180.

Normally, external I/O addresses should be chosen to avoid overlap with internal I/O addresses to avoid duplicate I/O accesses.

	Register	Mnemonic	Address	
			Binary	Hexadecimal
ASCII	ASCII Control Register A Ch 0	CNTLA0	XX000000	00H
	ASCII Control Register A Ch 1	CNTLA1	XX000001	01H
	ASCII Control Register B Ch 0	CNTLB0	XX000010	02H
	ASCII Control Register B Ch 1	CNTLB1	XX000011	03H
	ASCII Status Register Ch 0	STAT0	XX000100	04H
	ASCII Status Register Ch 1	STAT1	XX000101	05H
	ASCII Transmit Data Register Ch 0	TDR0	XX000110	06H
	ASCII Transmit Data Register Ch 1	TDR1	XX000111	07H
	ASCII Receive Data Register Ch 0	RDR0	XX001000	08H
	ASCII Receive Data Register Ch 1	RDR1	XX001001	09H
CSI/O	CSI/O Control Register	CNTR	XX001010	0AH
	CSI/O Transmit/Receive Data Register	TRDR	XX001011	0BH
Timer	Timer Data Register Ch 0L	TMDROL	XX001100	0CH
	Timer Data Register Ch 0H	TMDROH	XX001101	0DH
	Reload Register Ch 0L	RLDROL	XX001110	0EH
	Reload Register Ch 0H	RLDROH	XX001111	0FH
	Timer Control Register	TCR	XX010000	10H
	Reserved		XX010001	11H
			}	}
			XX010011	13H
	Timer Data Register Ch 1L	TMDR1L	XX010100	14H
	Timer Data Register Ch 1H	TMDR1H	XX010101	15H
Reload Register Ch 1L	RLDR1L	XX010110	16H	
Reload Register Ch 1H	RLDR1H	XX010111	17H	
Others	Free Running Counter	FRC	XX011000	18H
	Reserved		XX011001	19H
			}	}
			XX011111	1FH

Table 4. I/O Address Map

	Register	Mnemonic	Address	
			Binary	Hexadecimal
DMA	DMA Source Address Register Ch 0L	SAR0L	XX100000	20H
	DMA Source Address Register Ch 0H	SAR0H	XX100001	21H
	DMA Source Address Register Ch 0B	SAR0B	XX100010	22H
	DMA Destination Address Register Ch 0L	DAR0L	XX100011	23H
	DMA Destination Address Register Ch 0H	DAR0H	XX100100	24H
	DMA Destination Address Register Ch 0B	DAR0B	XX100101	25H
	DMA Byte Count Register Ch 0L	BCR0L	XX100110	26H
	DMA Byte Count Register Ch 0H	BCR0H	XX100111	27H
	DMA Memory Address Register Ch 1L	MAR1L	XX101000	28H
	DMA Memory Address Register Ch 1H	MAR1H	XX101001	29H
	DMA Memory Address Register Ch 1B	MAR1B	XX101010	2AH
	DMA I/O Address Register Ch 1L	IAR1L	XX101011	2BH
	DMA I/O Address Register Ch 1H	IAR1H	XX101100	2CH
	Reserved		XX101101	2DH
	DMA Byte Count Register Ch 1L	BCR1L	XX101110	2EH
	DMA Byte Count Register Ch 1H	BCR1H	XX101111	2FH
	DMA Status Register	DSTAT	XX110000	30H
DMA Mode Register	DMODE	XX110001	31H	
DMA/WAIT Control Register	DCNTL	XX110010	32H	
INT	IL Register (Interrupt Vector Low Register)	IL	XX110011	33H
	INT/TRAP Control Register	ITC	XX110100	34H
	Reserved		XX110101	35H
	Register	Mnemonic	Address	
			Binary	Hexadecimal
Refresh	Refresh Control Register	RCR	XX110110	36H
	Reserved		XX110111	37H
MMU	MMU Common Base Register	CBR	XX111000	38H
	MMU Bank Base Register	BBR	XX111001	39H
	MMU Common Bank Area Register	CBAR	XX111010	3AH
I/O	Reserved		XX111011	3BH
			XX111101	3DH
	Operation Mode Control Register	OMCR	XX111110	3EH
	I/O Control Register	ICR	XX111111	3FH

Table 4. I/O Address Map (cont.)

## Memory Management Unit (MMU)

The Z80180 has an on-chip MMU which performs the translation of the CPU 64K byte (16-bit addresses 0000H to FFFFH) logical memory address space into a 1024K byte (20-bit addresses 00000H to FFFFFH) physical memory address space. Address translation occurs internally in parallel with other CPU operation.

**Logical Address Spaces.** The 64K byte CPU logical address space is interpreted by the MMU as consisting of up to three separate logical address areas, Common Area 0, Bank Area, and Common Area 1.

As shown in Fig. 23, a variety of logical memory configurations are possible. The boundaries between the Common and Bank Areas can be programmed with 4K byte resolution.

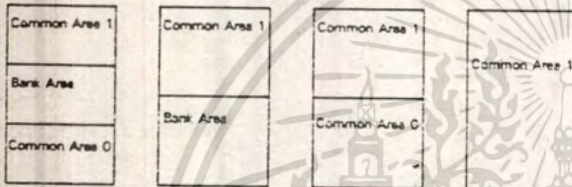

Figure 23. Logical Address Mapping Examples

**Logical to Physical Address Translation.** Fig. 24 shows an example in which the three logical address space portions are mapped into a 1024K byte physical address space. The important points to note are that Common and Bank Areas can overlap and that Common Area 1 and Bank Area can be freely relocated (on 4K bytes physical address boundaries). Common Area 0 (if it exists) is always based at physical address 00000H.

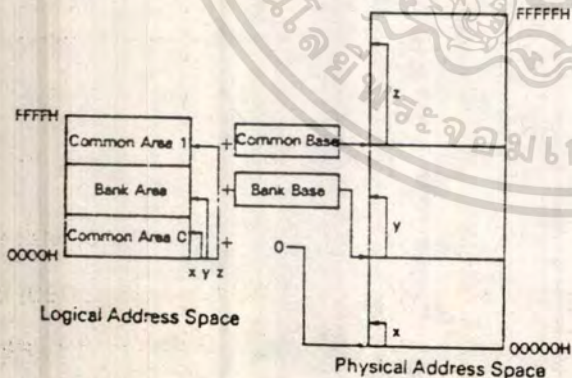

Figure 24. Physical Address Translation

**MMU Block Diagram.** The MMU block diagram is shown in Fig. 25. The MMU translates internal 16-bit logical addresses to external 20-bit physical addresses.

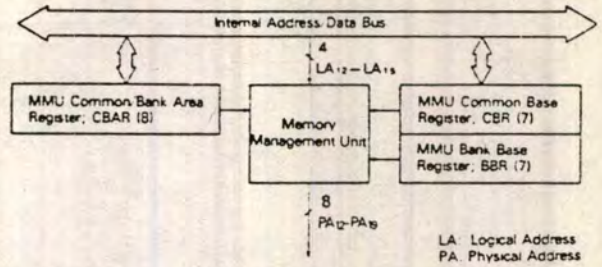

Figure 25. MMU Block Diagram

Whether address translation takes place depends on the type of CPU cycle as follows.

### (1) Memory Cycles

Address Translation occurs for all memory access cycles including instruction and operand fetches, memory data reads and writes, hardware interrupt vector fetch, and software interrupt restarts.

### (2) I/O Cycles

The MMU is logically bypassed for I/O cycles. The 16-bit logical I/O address space corresponds directly with the 16-bit physical I/O address space. The four high-order bits (A16-A19) of the physical address are always 0 during I/O cycles.

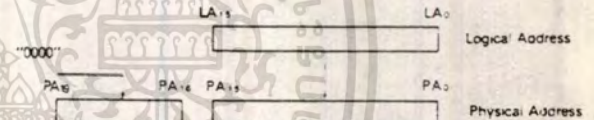

Figure 26. I/O Address Translation

### (3) DMA Cycles

When the Z80180 on-chip DMAC is using the external bus, the MMU is physically bypassed. The 20-bit source and destination registers in the DMAC are directly output on the physical address bus (A0-A19).

**MMU Registers.** Three MMU registers are used to program a specific configuration of logical and physical memory.

- (1) MMU Common/Bank Area Register (CBAR)
- (2) MMU Common Base Register (CBR)
- (3) MMU Bank Base Register (BBR)

CBAR is used to define the logical memory organization, while CBR and BBR are used to relocate logical areas within the 1024k byte physical address space. The resolution for both setting boundaries within the logical space and relocation within the physical space is 4k bytes.

The CAR field of CBAR determines the start address of Common Area 1 (Upper Common) and by default, the end

address of the Bank Area. The BAR field determines the start address of the Bank Area and by default, the end address of Common Area 0 (Lower Common).

The CA and BA fields of CBAR may be freely programmed subject only to the restriction that CA may never be less than BA. Fig. 27 and Fig. 28 show examples of logical memory organizations associated with different values of CA and BA.

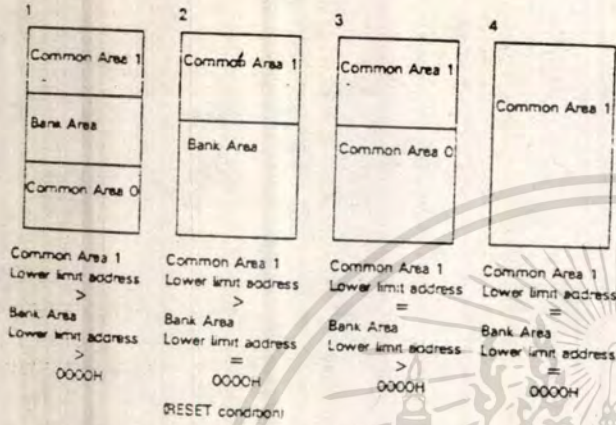

Figure 27. Logical Memory Organization

last address of the Bank Area. All bits of CA are set to 1 during RESET.

**BA-BAO: BA (bits 3-0)**

BA specifies the start (low) address (on 4k bytes boundaries) for the Bank Area. This also determines the last address of the Common Area 0. All bits of BA are set to 1 during RESET.

**MMU Common Base Register (CBR).** CBR specifies the base address (on 4k byte boundaries) used to generate a 20-bit physical address for Common Area 1 accesses. All bits of CBR are reset to 0 during RESET.

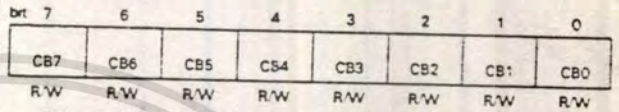

Figure 30. MMU Common Base Register (CBR : I/O Address = 38H)

**MMU Bank Base Register (BBR).** BBR specifies the base address (on 4k byte boundaries) used to generate a 19-bit physical address for Bank Area accesses. All bits of BBR are reset to 0 during RESET.

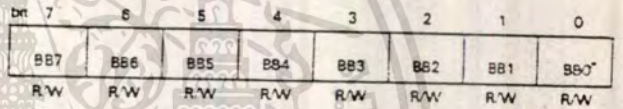

Figure 31. MMU Bank Base Register (BBR : I/O Address = 39H)

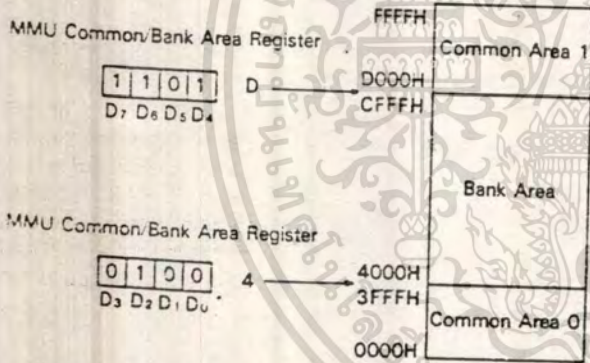

Figure 28. Logical Space Configuration (Example)

**MMU Register Description:**

**MMU Common/Bank Area Register (CBAR).** CBAR specifies boundaries within the Z80180 64K byte logical address space for up to three areas; Common Area 0, Bank Area and Common Area 1.

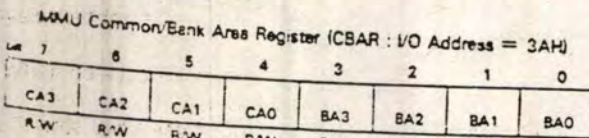

Figure 29. MMU Common/Bank Area Register (CBAR : I/O Address = 3AH)

**CA3-CA0: CA (bits 7-4)**

CA specifies the start (low) address (on 4K byte boundaries) for the Common Area 1. This also determines the

Physical address translation. Fig. 17 shows the way in which physical addresses are generated based on the contents of CBAR, CBR and BBR. MMU comparators classify an access by logical area as defined by CBAR. Depending on which of the three potential logical areas (Common Area 1, Bank Area, or Common Area 0) is being accessed, the appropriate 8-bit base address is added to the high-order 4 bits of the logical address, yielding a 20-bit physical address. CBR is associated with Common Area 1 accesses. Common Area 0, if defined, is always based at physical address 00000H.

**MMU Register Access Timing.** When data is written into CBAR, CBR or BBR, the value will be effective from the cycle immediately following the I/O write cycle which updates these registers.

Care must be taken during MMU programming to insure that CPU program execution is not disrupted. Observe that the next cycle following MMU register programming will

normally be an op-code fetch from the newly translated address. One simple technique is to localize all MMU

programming routines in a Common Area that is always enabled.

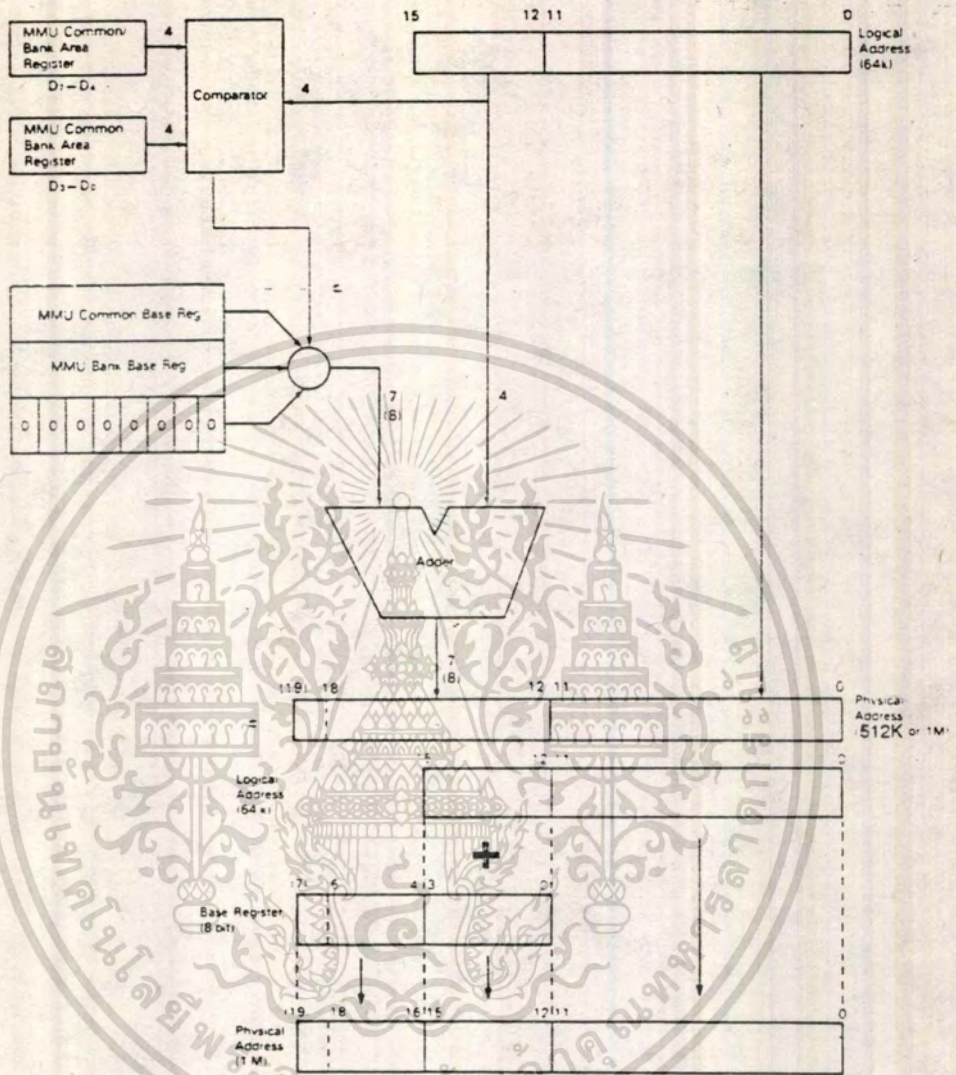

Figure 32. Physical Address Generation

## Interrupts

The Z80180 CPU has twelve interrupt sources, 4 external and 8 internal, with fixed priority. (Reference Figure 33.)

This section explains the CPU registers associated with interrupt processing, the TRAP interrupt, interrupt response modes, and the external interrupts. The detailed discussion of internal interrupt generation (except TRAP) is presented in the appropriate hardware section (i.e. PRT, DMAC, ASCI, and CSI/O).

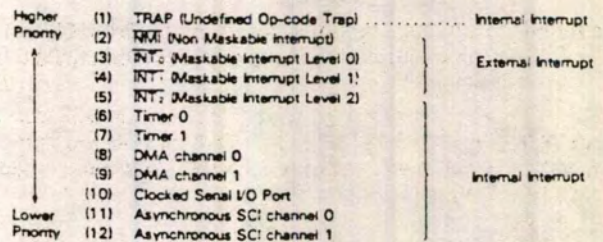

Figure 33. Interrupt Sources

**Interrupt Control Registers and Flags.** The Z80180 has three registers and two flags which are associated with interrupt processing.

Function	Name	Access Method
(1) Interrupt Vector High	I	LD A, I and LD I, A instructions
(2) Interrupt Vector Low	IL	I/O instruction (addr=33H)
(3) Interrupt/Trap Control	ITC	I/O instruction (addr=34H)
(4) Interrupt Enable Flag	IEF <sub>1</sub> , IEF <sub>2</sub>	EI and DI

**Interrupt Vector Register (I)**

Mode 2 for INT<sub>0</sub> external interrupt, INT<sub>1</sub> and INT<sub>2</sub> external interrupts, and all internal interrupts (except TRAP) use a programmable vectored technique to determine the address at which interrupt processing starts. In response to the interrupt a 16-bit address is generated. This address accesses a vector table in memory to obtain the address at which execution restarts.

While the method for generation of the least significant byte of the table address differs, all vectored interrupts use the contents of I as the most significant byte of the table address. By programming the contents of I, vector tables can be relocated on 256 byte boundaries throughout the 64K byte logical address space.

Note that I is read/written with the LD A, I and LD I, A instructions rather than I/O (IN, OUT) instructions. I is initialized to 00H during RESET.

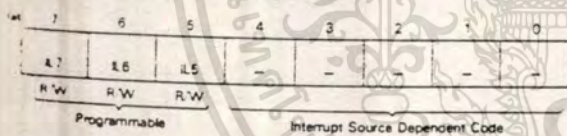

Figure 34. Interrupt Vector Low Register (IL : I/O Address = 33H)

**Interrupt Vector Low Register**

This register determines the most significant three bits of the low-order byte of the interrupt vector table address for external interrupts INT<sub>1</sub> and INT<sub>2</sub> and all internal interrupts (except TRAP). The five least significant bits are fixed for each specific interrupt source. By programming IL, the vector table can be relocated on 32 byte boundaries. IL is initialized to 00H during RESET.

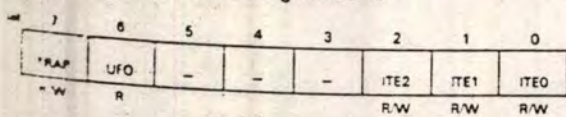

Figure 35. INT/TRAP Control Register (ITC : I/O Address = 34H)

ITC is used to handle TRAP interrupts and to enable or disable the external maskable interrupt inputs INT<sub>0</sub>, INT<sub>1</sub> and INT<sub>2</sub>.

**TRAP (bit 7)**

This bit is set to 1 when an undefined op-code is fetched. TRAP can be reset under program control by writing it with 0, however, it cannot be written with 1 under program control. TRAP is reset to 0 during RESET.

**UFO: Undefined Fetch Object (bit 6)**

When a TRAP interrupt occurs the contents of UFO allow determination of the starting address of the undefined instruction. This is necessary since the TRAP may occur on either the second or third byte of the op-code. UFO allows the stacked PC value to be correctly adjusted. If UFO = 0, the first op-code should be interpreted as the stacked PC-1. If UFO = 1, the first op-code address is stacked PC-2. UFO is read-only.

**ITE2,1,0: Interrupt Enable 2,1,0 (bits 2-0)**

ITE<sub>2</sub>, ITE<sub>1</sub> and ITE<sub>0</sub> enable and disable the external interrupt inputs INT<sub>2</sub>, INT<sub>1</sub> and INT<sub>0</sub>, respectively. If reset to 0, the interrupt is masked. During RESET, ITE<sub>0</sub> is initialized to 1 while ITE<sub>1</sub> and ITE<sub>2</sub> are initialized to 0.

**Interrupt Enable Flag 1,2 (IEF<sub>1</sub>, IEF<sub>2</sub>)**

IEF<sub>1</sub> controls the overall enabling and disabling of all internal and external maskable interrupts (i.e. all interrupts except NMI and TRAP).

If IEF<sub>1</sub> = 0, all maskable interrupts are disabled. IEF<sub>1</sub> can be reset to 0 by the DI (Disable Interrupts) instruction and set to 1 by the EI (Enable Interrupts) instruction.

The purpose of IEF<sub>2</sub> is to correctly manage the occurrence of NMI. During NMI, the prior interrupt reception state is saved and all maskable interrupts are automatically disabled (IEF<sub>1</sub> copied to IEF<sub>2</sub> and then IEF<sub>1</sub> cleared to 0). At the end of the NMI interrupt service routine, execution of the RETN (Return from Non-maskable Interrupt) will automatically restore the interrupt receiving state (by copying IEF<sub>2</sub> to IEF<sub>1</sub>) prior to the occurrence of NMI.

IEF<sub>2</sub> state can be reflected in the P/V bit of the CPU Status Register by executing LD A, I or LD A, R instructions.

CPU Operation	IEF <sub>1</sub>	IEF <sub>2</sub>	REMARKS
RESET	0	0	Inhibits the interrupt except NMI and TRAP
NMI	0	IEF <sub>1</sub>	Copies the contents of IEF <sub>1</sub> to IEF <sub>2</sub>
RETN	IEF <sub>2</sub>	not affected	Returns from the NMI service routine
Interrupt except NMI and TRAP	0	0	Inhibits the interrupt except NMI and TRAP
RETI	not affected	not affected	
TRAP	not affected	not affected	
EI	1	1	
DI	0	0	
LD A, I	not affected	not affected	Transfers the contents of IEF <sub>2</sub> to P/V flag
LD A, R	not affected	not affected	Transfers the contents of IEF <sub>2</sub> to P/V flag

Table 5: State of IEF<sub>1</sub> and IEF<sub>2</sub>

**TRAP Interrupt.** The Z80180 generates a non-maskable (not affected by the state of IEF1) TRAP interrupt when an undefined op-code fetch occurs. This feature can be used to increase software reliability, implement an "extended" instruction set, or both. TRAP may occur during op-code fetch cycles and also if an undefined op-code is fetched during the interrupt acknowledge cycle for  $\overline{INT}_0$  when Mode 0 is used.

When a TRAP interrupt occurs the Z80180 operates as follows.

- (1) The TRAP bit in the Interrupt TRAP/Control (ITC) register is set to 1.
- (2) The current PC (Program Counter) value, reflecting location of the undefined op-code, is saved on the stack.
- (3) The Z80180 vectors to logical address 0. Note that if logical address 0000H is mapped to physical address 00000H, the vector is the same as for RESET. In this case, testing the TRAP bit in ITC will reveal whether the restart at physical address 00000H was caused by RESET or TRAP.

The state of the UFO (Undefined Fetch Object) bit in ITC allows TRAP manipulation software to correctly "adjust" the stacked PC, depending on whether the second or third byte of the op-code generated the TRAP. If UFO=0, the starting address of the invalid instruction is equal to the stacked PC-1. If UFO=1, the starting address of the invalid instruction is equal to the stacked PC-2.

Note that Bus Release cycle, Refresh cycle, DMA cycle, and WAIT cycle cannot be inserted just after TTP state which is inserted for TRAP interrupt sequence. Figure 36 shows TRAP Timing - 2nd Op-code undefined and Figure 37 shows Trap Timing - 3rd Op-code undefined.

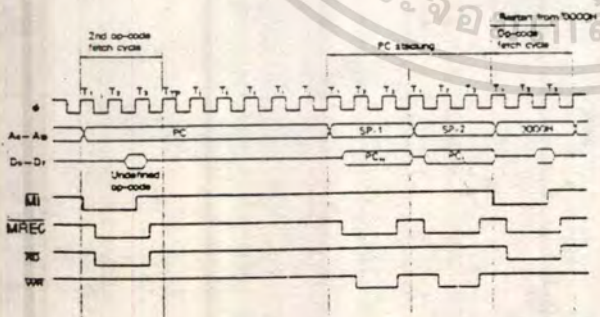

Figure 36. TRAP Timing-2<sup>nd</sup> Op-Code Undefined

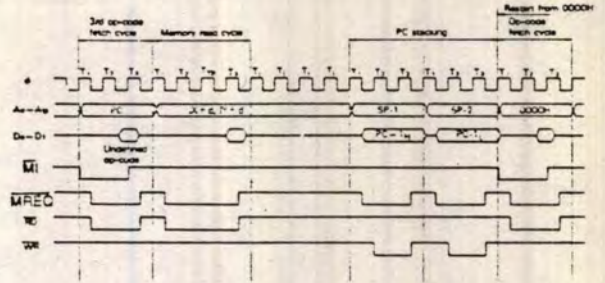

Figure 37. TRAP Timing-3<sup>rd</sup> Op-Code Undefined

**External Interrupts.** The Z80180 has four external hardware interrupt inputs.

- (1)  $\overline{NMI}$  - Non-maskable Interrupt
- (2)  $\overline{INT}_0$  - Maskable Interrupt Level 0
- (3)  $\overline{INT}_1$  - Maskable Interrupt Level 1
- (4)  $\overline{INT}_2$  - Maskable Interrupt Level 2

$\overline{NMI}$ ,  $\overline{INT}_1$  and  $\overline{INT}_2$  have fixed interrupt response modes.  $\overline{INT}_0$  has 3 different software programmable interrupt response modes - Mode 0, Mode 1 and Mode 2.

**$\overline{NMI}$  - Non-Maskable Interrupt.** The  $\overline{NMI}$  interrupt input is edge sensitive and cannot be masked by software. When  $\overline{NMI}$  is detected, the Z80180 operates as follows.

- (1) DMAC operation is suspended by the clearing of the DME (DMA Main Enable) bit in DCNTL.
- (2) The PC is pushed onto the stack.
- (3) The contents of IEF<sub>1</sub> are copied to IEF<sub>2</sub>. This saves the interrupt reception state that existed prior to  $\overline{NMI}$ .
- (4) IEF<sub>1</sub> is cleared to 0. This disables all external and internal maskable interrupts (i.e. all interrupts except  $\overline{NMI}$  and TRAP).
- (5) Execution commences at logical address 0066H.

The last instruction of an  $\overline{NMI}$  service routine should be RETN (Return from Non-maskable Interrupt). This restores the stacked PC, allowing the interrupted program to continue. Furthermore, RETN causes IEF<sub>2</sub> to be copied to IEF<sub>1</sub>, restoring the interrupt reception state that existed prior to  $\overline{NMI}$ .

Note that  $\overline{NMI}$ , since it can be accepted during Z80180 on-chip DMAC operation, can be used to externally interrupt DMA transfer. The  $\overline{NMI}$  service routine can reactivate or abort the DMAC operation as required by the application.

For  $\overline{NMI}$ , special care must be taken to insure that interrupt inputs do not "overrun" the  $\overline{NMI}$  service routine. Unlimited  $\overline{NMI}$  inputs without a corresponding number of RETN instructions will eventually cause stack overflow.

Fig. 38 shows the use of  $\overline{\text{NMI}}$  and  $\text{RETN}$  while Fig. 39 details  $\overline{\text{NMI}}$  response timing.  $\overline{\text{NMI}}$  is edge sensitive and the internally latched  $\overline{\text{NMI}}$  falling edge is held until it is sampled. If the falling edge of  $\overline{\text{NMI}}$  is latched before the falling edge of clock state prior to T3 or T1 in the last machine cycle, the internally latched  $\overline{\text{NMI}}$  is sampled at the falling edge of the clock state prior to T3 or T1 in the last machine cycle and  $\overline{\text{NMI}}$  acknowledge cycle begins at the end of the current machine cycle.

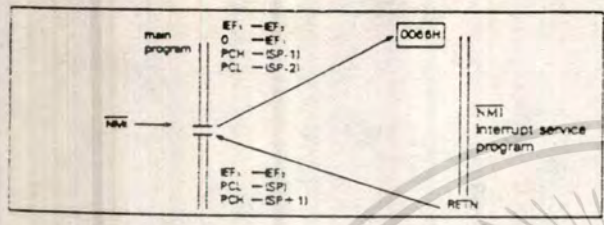

Figure 38.  $\overline{\text{NMI}}$  Use

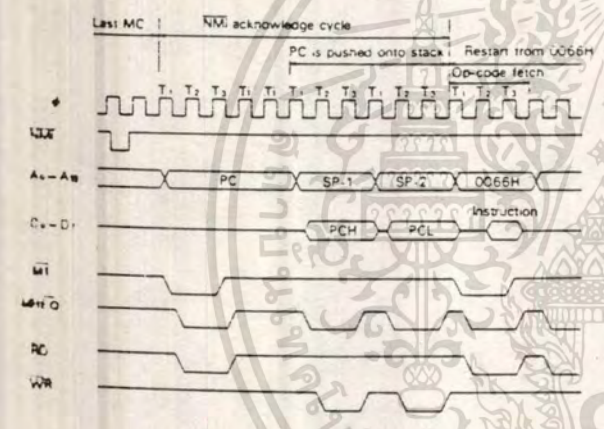

Figure 39.  $\overline{\text{NMI}}$  Timing

(2) Mode 1 - Restart at logical address 0038H.

(3) Mode 2 - Low byte vector table address fetch from data bus.

$\overline{\text{INT}}_0$  Mode 0.

During the interrupt acknowledge cycle, an instruction is fetched from the data bus (D0-D7) at the rising edge of T3. Often, this instruction is one of the eight single byte RST (RESTART) instructions which stack the PC and restart execution at a fixed logical address. However, multibyte instructions can be processed if the interrupt acknowledging device can provide a multibyte response. Unlike all other interrupts, the PC is not automatically stacked.

Note that TRAP interrupt will occur if an invalid instruction is fetched during Mode 0 interrupt acknowledge. (Reference Figure 40.)

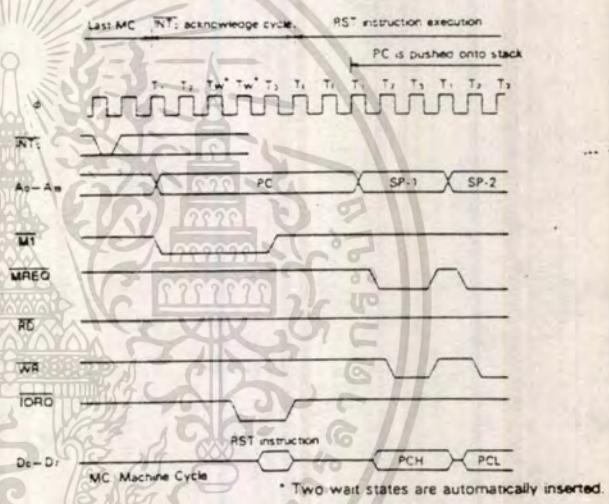

Figure 40.  $\overline{\text{INT}}_0$  Mode 0 Timing

$\overline{\text{INT}}_0$  - Maskable Interrupt Level 0

The next highest priority external interrupt after  $\overline{\text{NMI}}$  is  $\overline{\text{INT}}_0$ .  $\overline{\text{INT}}_0$  is sampled at the falling edge of the clock state prior to T3 or T1 in the last machine cycle. If  $\overline{\text{INT}}_0$  is asserted LOW at the falling edge of the clock state prior to T3 or T1 in the last machine cycle,  $\overline{\text{INT}}_0$  is accepted. The interrupt is masked if either the IEF1 flag or the ITE0 (Interrupt Enable 0) bit in ITC are reset to 0. Note that after RESET the state is as follows:

- (1) IEF1 is 0, so  $\overline{\text{INT}}_0$  is masked.
- (2) ITE0 is 1, so  $\overline{\text{INT}}_0$  is enabled by execution of the EI (Enable Interrupts) instruction.

The  $\overline{\text{INT}}_0$  interrupt is unique in that 3 programmable interrupt response modes are available - Mode 0, Mode 1 and Mode 2. The specific mode is selected with the IM 0, IM 1 and IM 2 (Set Interrupt Mode) instructions. During RESET, the 250180 is initialized to use Mode 0 for  $\overline{\text{INT}}_0$ . The 3 interrupt response modes for  $\overline{\text{INT}}_0$  are:

(1) Mode 0 - Instruction fetch from data bus.

$\overline{\text{INT}}_0$  Mode 1

When  $\overline{\text{INT}}_0$  is received, the PC is stacked and instruction execution restarts at logical address 0038H. Both IEF1 and IEF2 flags are reset to 0, disabling all maskable interrupts. The interrupt service routine should normally terminate with the EI (Enable Interrupts) instruction followed by the RETI (Return from Interrupt) instruction, to reenables the interrupts. Fig. 41 shows the use of  $\overline{\text{INT}}_0$  (Mode 1) and RETI for the Mode 1 interrupt sequence.

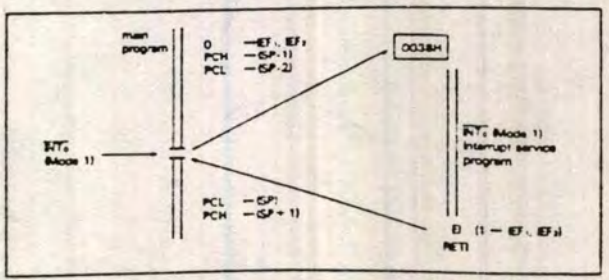

Figure 41.  $\overline{\text{INT}}_0$  Mode 1 Interrupt Sequence

Fig. 42 shows  $\overline{INT}_0$  Mode 1 timing.

### $\overline{INT}_0$ Mode 2

This method determines the restart address by reading the contents of a table residing in memory. The vector table consists of up to 128 two-byte restart addresses stored in low byte, high byte order.

The vector table address is located on 256 byte boundaries in the 64K byte logical address space programmed in the 8-bit Interrupt Vector Register (I). Fig. 43 shows the  $\overline{INT}_0$  Mode 2 Vector acquisition.

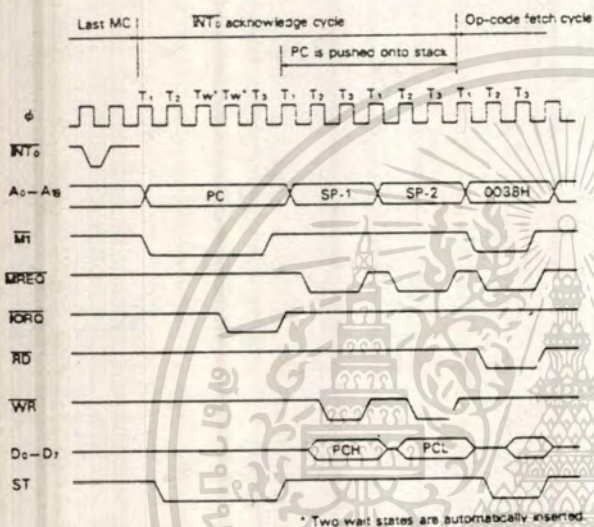

Figure 42.  $\overline{INT}_0$  Mode 1 Timing

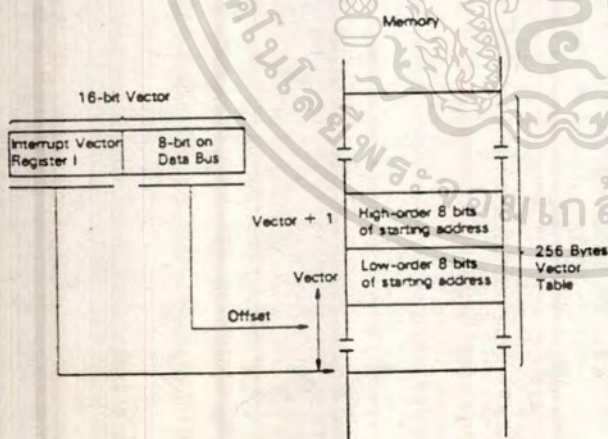

Figure 43.  $\overline{INT}_0$  Mode 2 Vector Acquisition

During the  $\overline{INT}_0$  Mode 2 acknowledge cycle, the low-order 8 bits of the vector is fetched from the data bus at the rising edge of T3 and the CPU acquires the 16-bit vector.

Next, the PC is stacked. Finally, the 16-bit restart address is fetched from the vector table and execution begins at that address.

Note that external vector acquisition is indicated by both  $\overline{M1}$  and  $\overline{IORQ}$  LOW. Two wait states (Tw) are automatically inserted for external vector fetch cycles.

During RESET the Interrupt Vector Register (I) is initialized to 00H and, if necessary, should be set to a different value prior to the occurrence of a Mode 2  $\overline{INT}_0$  interrupt. Fig. 44 shows  $\overline{INT}_0$  interrupt Mode 2 Timing.

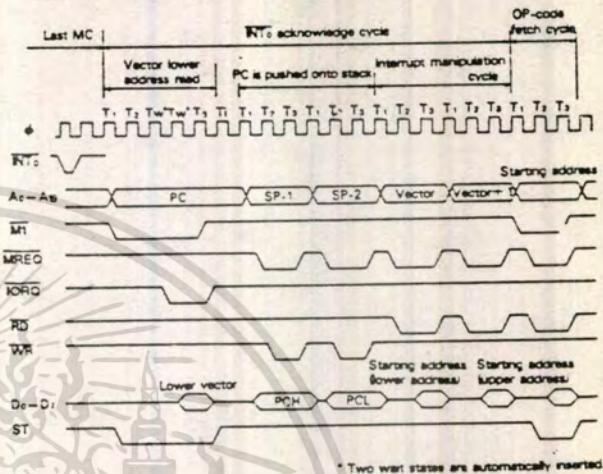

Figure 44.  $\overline{INT}_0$  Interrupt Mode 2 Timing

### $\overline{INT}_1, \overline{INT}_2$

The operation of external interrupts  $\overline{INT}_1$  and  $\overline{INT}_2$  is a vector mode similar to  $\overline{INT}_0$  Mode 2. The difference is that  $\overline{INT}_1$  and  $\overline{INT}_2$  generate the low-order byte of vector table address using the IL (Interrupt Vector Low) register rather than fetching it from the data bus. This is also the interrupt response sequence used for all internal interrupts (except TRAP).

As shown in Fig. 45, the low-order byte of the vector table address has the most significant 3 bits of the software programmable IL register while the least significant 5 bits are a unique fixed value for each interrupt ( $\overline{INT}_1, \overline{INT}_2$  and internal) source.

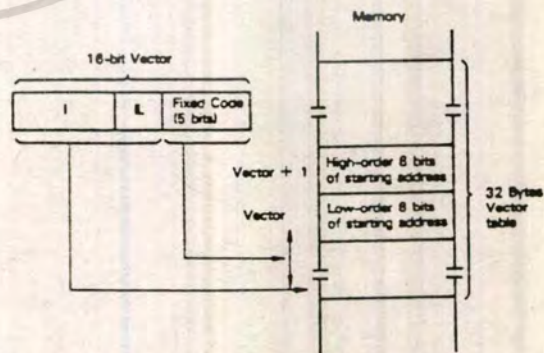

Figure 45.  $\overline{INT}_1, \overline{INT}_2$  Vector Acquisition

$\overline{INT}_1$  and  $\overline{INT}_2$  are globally masked by  $IEF1 = 0$ . Each is also individually maskable by respectively clearing the

ITE1 and ITE2 (bits 1,2) of the INT/TRAP control register to 0. During RESET, IEF1, ITE1 and ITE2 bits are reset to 0.

**Internal interrupts.** Internal interrupts (except TRAP) use the same vectored response mode as  $\overline{INT}_1$  and  $\overline{INT}_2$  (Fig. 45). Internal interrupts are globally masked by IEF1 = 0. Individual internal interrupts are enabled/disabled by programming each individual I/O (PRT, DMAC, CSI/O, ASCII) control register. The lower vector of  $\overline{INT}_1$ ,  $\overline{INT}_2$  and internal interrupt are summarized in Table 6.

Interrupt Source	Priority	IL			Fixed Code				
		b7	b6	b5	b4	b3	b2	b1	b0
$\overline{INT}_1$	Highest	*	*	*	0	0	0	0	0
$\overline{INT}_2$		*	*	*	0	0	0	1	0
PRT channel 0		*	*	*	0	0	1	0	0
PRT channel 1		*	*	*	0	0	1	1	0
DMA channel 0		*	*	*	0	1	0	0	0
DMA channel 1		*	*	*	0	1	0	1	0
CSI/O		*	*	*	0	1	1	0	0
ASCII channel 0		*	*	*	0	1	1	1	0
ASCII channel 1	Lowest	*	*	*	1	0	0	0	0

\* Programmable

Table 6. Vector Table

**Interrupt Acknowledge Cycle Timing**

Fig. 46 shows  $\overline{INT}_1$ ,  $\overline{INT}_2$ , and internal interrupts timing.  $\overline{INT}_1$  and  $\overline{INT}_2$  are sampled at the falling edge of the clock state prior to T<sub>2</sub> or T<sub>1</sub> in the last machine cycle. If  $\overline{INT}_1$  or  $\overline{INT}_2$  is asserted LOW at the falling edge of clock state prior to T<sub>3</sub> or T<sub>1</sub> in the last machine cycle, the interrupt request is accepted.

**Interrupt Sources During Reset:**

**Interrupt Vector Register (I).** All bits are reset to 0. Since I = 0 locates the vector tables starting at logical address 0000H, vectored interrupts ( $\overline{INT}_0$  Mode 2,  $\overline{INT}_1$ ,  $\overline{INT}_2$ , and internal interrupts) overlap with fixed restart interrupts like RESET (0), NMI (0066H),  $\overline{INT}_0$  Mode 1 (0038H) and RST (0000H-0038H). The vector table(s) are built elsewhere in memory and located on 356 byte boundaries by reprogramming I with the LD I, A instruction. **IL Register.** Bits 7 - 5 are reset to 0. The IL Register can be programmed to locate the vector

table for  $\overline{INT}_1$ ,  $\overline{INT}_2$  and internal interrupts on 32 byte sub-boundaries within the 256 byte area specified by I.

**IEF1, IEF2 Flags. Reset to 0.**

Interrupts other than NMI and TRAP are disabled.

**ITC Register. ITE0 set to 1. ITE1, ITE2 reset to 0.**

$\overline{INT}_0$  can be enabled by the EI instruction, which sets IEF1 = 1. To enable  $\overline{INT}_1$  and  $\overline{INT}_2$  also requires that the ITE1 and ITE2 bits be respectively set = 1 by writing to ITC.

**I/O Control Registers. Interrupt enable bits reset to 0.**

All Z80180 on-chip I/O (PRT, DMAC, CSI/O, ASCII) interrupts are disabled and can be individually enabled by writing to each I/O control register interrupt enable bit.

**RETI Instruction Sequence:**

When the EDH/4DH sequence is fetched by the Z80180, it is recognized as the RETI instruction sequence. The Z80180 will then refetch the RETI instruction with 4 T-states in the EDH cycle to allow the Z80 peripherals time to decode that cycle (See Figure 47). This allows the internal interrupt structure of the peripheral to properly decode the instruction and behave accordingly.

The M1E bit of the Operation Mode Control Register (OMCR) should be set to 0 so that M1 signal is active only during the refetch of the RETI instruction sequence. This is the desired operation when Z80 peripherals are connected to the Z80180.

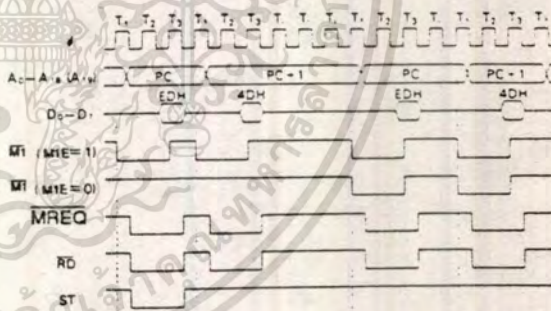

Figure 47. RETI Instruction Sequence

The RETI instruction takes 22 T-states and 10 machine cycles. Table 7 lists the conditions of all the control signals during this sequence for the Z80180.

Machine Cycle	States	Address	Data	RD	WR	M1					
						MREQ	IOR0	IOC-1	IOC-0	HALT	ST
1	T1-T3	1st Opcode	EDH	0	1	0	1	0	1	1	0
2	T1-T3	2nd Opcode	4DH	0	1	0	1	0	1	1	1
3	T1	don't care	3-state	1	1	1	1	1	1	1	1
4	T1	don't care	3-state	1	1	1	1	1	1	1	1
5	T1	don't care	3-state	1	1	1	1	1	1	1	1
6	T1-T3	1st Opcode	EDH	0	1	0	1	0	0	1	1
7	T1	don't care	3-state	1	1	1	1	1	1	1	1
8	T1-T3	2nd Opcode	4DH	0	1	0	1	0	1	1	1
9	T1-T3	SP	data	0	1	0	1	1	1	1	1
10	T1-T3	SP+1	data	0	1	0	1	1	1	1	1

Table 7. RETI Control Signal States

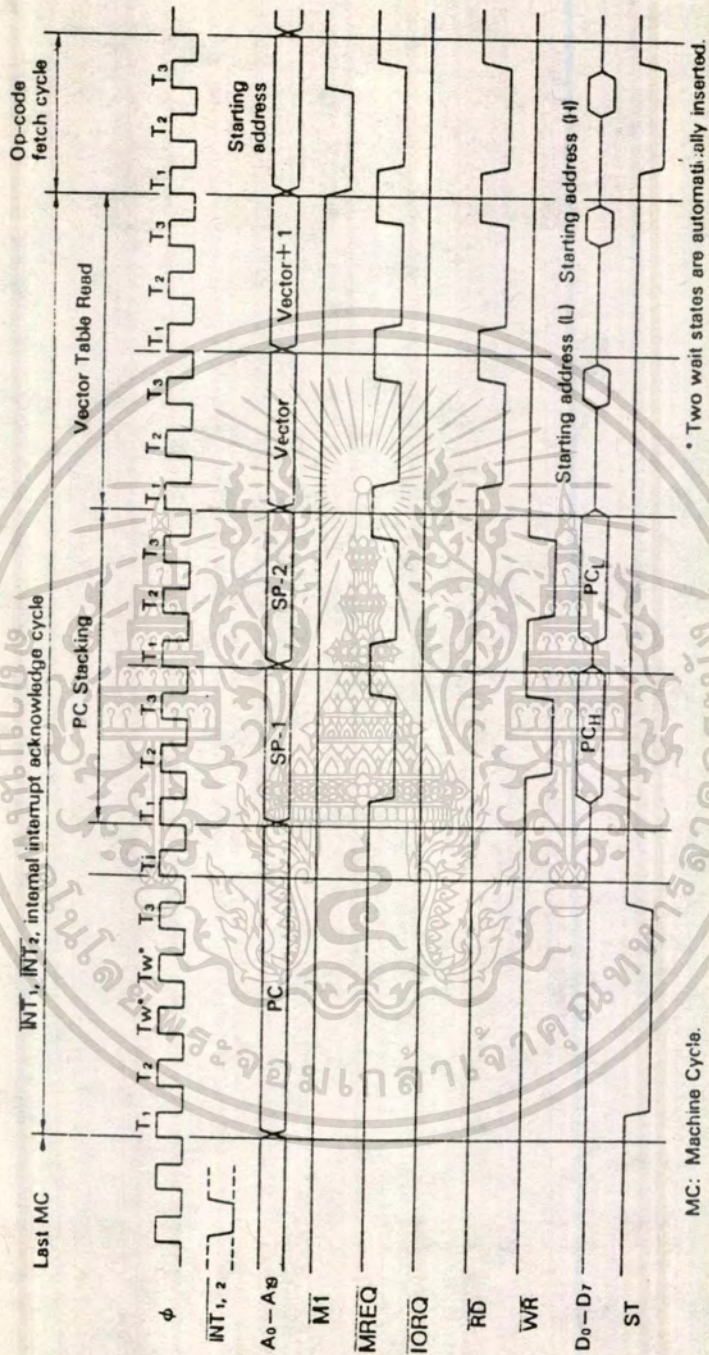

Figure 46.  $INT_1$ ,  $INT_2$ , and Internal Interrupts Timing

## Dynamic RAM Refresh Control

The Z80180 incorporates a dynamic RAM refresh control circuit including 8-bit refresh address generation and programmable refresh timing. This circuit generates asynchronous refresh cycles inserted at the programmable interval independent of CPU program execution. For systems which do not use dynamic RAM, the refresh function can be disabled.

When the internal refresh controller determines that a refresh cycle should occur, the current instruction is interrupted at the first breakpoint between machine cycles. The refresh cycle is inserted by placing the refresh address on A<sub>0</sub>-A<sub>7</sub> and the  $\overline{\text{RFSH}}$  output is driven LOW.

Refresh cycles may be programmed to be either 2 or 3 clock cycles in duration by programming the REFW (Refresh Wait) bit in the Refresh Control Register (RCR). Note that the external WAIT input and the internal wait state generator are not effective during refresh.

Fig. 48 shows the timing of a refresh cycle with a refresh wait (TRW) cycle.

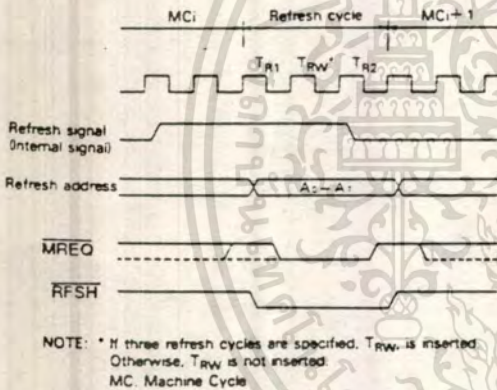

Figure 48. Refresh Cycle Timing

Refresh Control Register (RCR). The RCR specifies the interval and length of refresh cycles, while enabling or disabling the refresh function.

bit	7	6	5	4	3	2	1	0
REFE	REFW	-	-	-	-	CYC1	CYC0	
R/W	R/W					R/W	R/W	

Figure 49. Refresh Control Register (RCA: I/O Address = 36H)

**REFE: Refresh Enable (bit 7)**  
REFE = 0 disables the refresh controller while REFE = 1 enables refresh cycle insertion. REFE is set to 1 during RESET.

**REFW: Refresh Wait (bit 6)**  
REFW = 0 causes the refresh cycle to be two clocks in duration. REFW = 1 causes the refresh cycle to be three

clocks in duration by adding a refresh wait cycle (TRW). REFW is set to 1 during RESET.

### CYC1, 0: Cycle Interval (bit 1, 0)

CYC1 and CYC0 specify the interval (in clock cycles) between refresh cycles. In the case of dynamic RAMs requiring 128 refresh cycles every 2 ms (or 256 cycles in every 4 ms), the required refresh interval is less than or equal to 15.625  $\mu\text{s}$ . Thus, the underlined values indicate the best refresh interval depending on CPU clock frequency. CYC0 and CYC1 are cleared to 0 during RESET. Reference Table 8.

CYC1	CYC0	Insertion interval	Time interval				
			10 MHz	8 MHz	6 MHz	4 MHz	2.5 MHz
0	0	10 states	110 $\mu\text{s}$ *	112.5 $\mu\text{s}$ *	166 $\mu\text{s}$	2.5 $\mu\text{s}$	40 $\mu\text{s}$
0	1	20 states	220 $\mu\text{s}$ *	225 $\mu\text{s}$ *	333 $\mu\text{s}$	5.0 $\mu\text{s}$	80 $\mu\text{s}$
1	0	40 states	440 $\mu\text{s}$ *	500 $\mu\text{s}$ *	666 $\mu\text{s}$	10.0 $\mu\text{s}$	160 $\mu\text{s}$
1	1	80 states	880 $\mu\text{s}$ *	1000 $\mu\text{s}$ *	1333 $\mu\text{s}$	20.0 $\mu\text{s}$	320 $\mu\text{s}$

\* calculated interval

Table 8. DRAM Refresh Intervals

Refresh Control And Reset. After RESET, based on the initialized value of RCR, refresh cycles will occur with an interval of 10 clock cycles and be 3 clock cycles in duration.

### Dynamic Ram Refresh Operation Notes.

(1) Refresh Cycle insertion is stopped when the CPU is in the following states:

- During RESET.
- When the bus is released in response to  $\overline{\text{BUSREQ}}$ .
- During SLEEP mode.
- During WAIT states.

(2) Refresh cycles are suppressed when the bus is released in response to  $\overline{\text{BUSREQ}}$ . However, the refresh timer continues to operate. Thus, the time at which the first refresh cycle occurs after the Z80180 re-acquires the bus depends on the refresh timer and has no timing relationship with the bus exchange.

(3) Refresh cycles are suppressed during SLEEP mode. If a refresh cycle is requested during SLEEP mode, the refresh cycle request is internally "latched" (until replaced with the next refresh request). The "latched" refresh cycle is inserted at the end of the first machine cycle after SLEEP mode is exited. After this initial cycle, the time at which the next refresh cycle occurs depends on the refresh time and has no timing relationship with the exit from SLEEP mode.

(4) Regarding (2) and (3), the refresh address is incremented by one for each successful refresh cycle, not for

each refresh request. Thus, independent of the number of "missed" refresh requests, each refresh bus cycle will use

a refresh address incremented by one from that of the previous refresh bus cycles.

## DMA Controller (DMAC)

The Z80180 contains a two-channel DMA (Direct Memory Access) controller which supports high speed data transfer. Both channels (channel 0 and channel 1) have the following capabilities.

**Memory Address Space.** Memory source and destination addresses can be directly specified anywhere within the 1024K byte physical address space using 20-bit source and destination memory addresses. In addition, memory transfers can arbitrarily cross 64K byte physical address boundaries without CPU intervention.

**I/O Address Space.** I/O source and destination addresses can be directly specified anywhere within the 64K byte I/O address space (16-bit source and destination I/O addresses).

**Transfer Length.** Up to 64K bytes are transferred based on a 16-bit byte count register.

**DREQ Input.** Level and edge sense DREQ input detection are selectable.

**TEND Output.** Used to indicate DMA completion to external devices.

**Transfer Rate.** Each byte transfer can occur every 6 clock cycles. Wait states can be inserted in DMA cycles for slow memory or I/O devices. At the system clock ( $f$ ) = 6 MHz, the DMA transfer rate is as high as 1.0 megabytes/second (no wait states).

There is an additional feature for DMA interrupt request by DMA END. Each channel has the following additional specific capabilities.

### Channel 0

Memory ↔ memory, memory ↔ I/O, memory ↔ memory mapped I/O transfers.

- Memory address increment, decrement, no-change.
- Burst or cycle steal memory to/from memory transfers.
- DMA to/from both ASCII channels.
- Higher priority than DMAC channel 1.

### Channel 1

Memory ↔ I/O transfer.  
Memory address increment, decrement

### DMAC Registers

Each channel of the DMAC (channel 0, 1) has three registers specifically associated with that channel.

### Channel 0

SAR0 - Source Address Register  
DAR0 - Destination Address Register  
BCR0 - Byte Count Register

### Channel 1

MAR1 - Memory Address Register  
IAR1 - I/O Address Register  
BCR1 - Byte Count Register

The two channels share the following three additional registers in common.

DSTAT - DMA Status Register  
DMODE - DMA Mode Register  
DCNTL - DMA Control Register

DMAC Block Diagram. Fig. 50 shows the Z64180 DMAC Block Diagram.

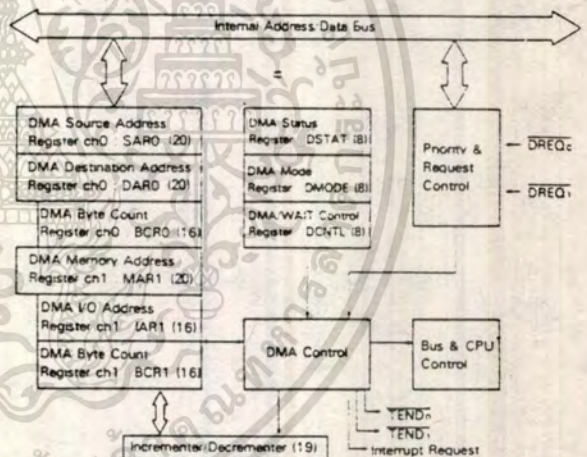

Figure 50. DMAC Block Diagram

### DMAC Register Description.

**DMA Source Address Register Channel 0 (SAR0: I/O Address = 20H to 22H)**

Specifies the physical source address for channel 0 transfers. The register contains 20 bits and can specify up to 1024K byte memory addresses or up to 64K byte I/O addresses. Channel 0 source can be memory, I/O, or memory mapped I/O.

**DMA Destination Address Register Channel 0 (DAR0: I/O Address = 23H to 25H)**

Specifies the physical destination address for channel 0 transfers. The register contains 20 bits and can specify up

to 1024K byte memory addresses or up to 64K byte I/O addresses. Channel 0 destination can be memory, I/O, or memory mapped I/O.

**DMA Byte Count Register Channel 0 (BCRO: I/O Address = 26H to 27H)**

Specifies the number of bytes to be transferred. This register contains 16 bits and may specify up to 64K byte transfers. When one byte is transferred, the register is decremented by one. If "n" bytes are transferred, "n" is stored before the DMA operation.

**DMA Memory Address Register Channel 1 (MAR1: I/O Address = 28H to 2AH)**

Specifies the physical memory address for channel 1 transfers. This may be destination or source memory address. The register contains 20 bits and may specify up to 1024K byte memory address.

**DMA I/O Address Register Channel 1 (IAR1: I/O Address = 2BH to 2CH)**

Specifies the I/O address for channel 1 transfers. This may be destination or source I/O address. The register contains 16 bits and may specify up to 64K byte I/O addresses.

**DMA Byte Count Register Channel 1 (BCR1: I/O Address = 2EH to 2FH)**

Specifies the number of bytes to be transferred. This register contains 16 bits and may specify up to 64K byte transfers. When one byte is transferred, the register is decremented by one.

**DMA Status Register (DSTAT)**

DSTAT is used to enable and disable DMA transfer and DMA termination interrupts. DSTAT also determines DMA transfer status, i.e. completed or in progress.

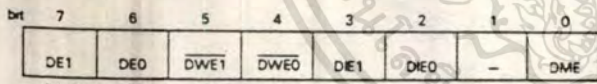

Figure 51. DMA Status Register (DSTAT: I/O Address = 30H)

**DE1: DMA Enable Channel 1 (bit 7)**

When DE1 = 1 and DME = 1, channel 1 DMA is enabled. When a DMA transfer terminates (BCR1 = 0), DE1 is reset to 0 by the DMAC. When DE1 = 0 and the DMA interrupt is enabled (DIE1 = 1), a DMA interrupt request is made to the CPU.

To perform a software write to DE1, DWE1 is written with 0 during the same register write access. Writing DE1 to 0 disables channel 1 DMA, but DMA is restartable. Writing DE1 to 1 enables channel 1 DMA and automatically sets DME (DMA Main Enable) to 1. DE1 is cleared to 0 during RESET.

**DE0: DMA Enable Channel 0 (bit 6)**

When DE0 = 1 and DME = 1, channel 0 DMA is enabled. When a DMA transfer terminates (BCR0 = 0), DE0 is reset

to 0 by the DMAC. When DE0 = 0 and the DMA interrupt is enabled (DIE0 = 1), a DMA interrupt request is made to the CPU.

To perform a software write to DE0, DWE0 should be written with 0 during the same register write access. Writing DE0 to 0 disables channel 0 DMA. Writing DE0 to 1 enables channel 0 DMA and automatically sets DME (DMA Main Enable) to 1. DE0 is cleared to 0 during RESET.

**DWE1: DE1 Bit Write Enable (bit 5)**

When performing any software write to DE1, DWE1 should be written with 0 during the same access. DWE1 write value of 0 is not held and DWE1 is always read as 1.

**DWE0: DE0 Bit Write Enable (bit 4)**

When performing any software write to DE0, DWE0 should be written with 0 during the same access. DWE0 write value of 0 is not held and DWE0 is always read as 1.

**DIE1: DMA Interrupt Enable Channel 1 (bit 3)**

When DIE1 is set to 1, the termination channel 1 DMA transfer (indicated when DE1 = 0) causes a CPU interrupt request to be generated. When DIE1 = 0, the channel 1 DMA termination interrupt is disabled. DIE1 is cleared to 0 during RESET.

**DIE0: DMA Interrupt Enable Channel 0 (bit 2)**

When DIE0 is set to 1, the termination channel 0 of DMA transfer (indicated when DE0 = 0) causes a CPU interrupt request to be generated. When DIE0 = 0, the channel 0 DMA termination interrupt is disabled. DIE0 is cleared to 0 during RESET.

**DME: DMA Main Enable (bit 0)**

A DMA operation is only enabled when its DE bit (DE0 for channel 0, DE1 for channel 1) and the DME bit are set to 1.

When NMI occurs, DME is reset to 0, thus disabling DMA activity during the NMI interrupt service routine. To restart DMA, DE0 and/or DE1 should be written with 1 (even if the contents are already 1). This automatically sets DME to 1, allowing DMA operations to continue. Note that DME cannot be directly written. It is cleared to 0 by NMI or indirectly set to 1 by setting DE0 and/or DE1 to 1. DME is cleared to 0 during RESET.

**DMA Mode Register (DMODE)**

DMODE is used to set the addressing and transfer mode for channel 0.

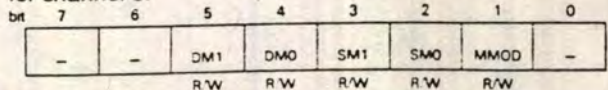

Figure 52. DMA Mode Register (DMODE: I/O Address = 31H)

**DM1, DM0: Destination Mode Channel 0 (bits 5,4)**

Specifies whether the destination for channel 0 transfers is memory, I/O or memory mapped I/O and the corresponding address modifier. DM1 and DM0 are cleared to 0 during RESET.

DM1	DM0	Memory/I/O	Address Increment/Decrement
0	0	Memory	+ 1
0	1	Memory	- 1
1	0	Memory	fixed
1	1	I/O	fixed

Table 9: Channel 0 Destination

**SM1, SM0: Source Mode Channel 0 (bits 3,2)**

Specifies whether the source for channel 0 transfers is memory, I/O, or memory mapped I/O and the corresponding address modifier. SM1 and SM0 are cleared to 0 during RESET.

SM1	SM0	Memory/I/O	Address Increment/Decrement
0	0	Memory	+ 1
0	1	Memory	- 1
1	0	Memory	fixed
1	1	I/O	fixed

Table 10: Channel 0 Source

Table 11 shows all DMA transfer mode combinations of DM0, DM1, SM0, SM1. Since I/O to/from I/O transfers are not implemented, 12 combinations are available.

DM1	DM0	SM1	SM0	Transfer Mode	Address Increment/Decrement
0	0	0	0	Memory→Memory	SAR0+1, DAR0+1
0	0	0	1	Memory→Memory	SAR0-1, DAR0+1
0	0	1	0	Memory→Memory	SAR0 fixed, DAR0+1
0	0	1	1	I/O→Memory	SAR0 fixed, DAR0+1
0	1	0	0	Memory→Memory	SAR0+1, DAR0-1
0	1	0	1	Memory→Memory	SAR0-1, DAR0-1
0	1	1	0	Memory→Memory	SAR0 fixed, DAR0-1
0	1	1	1	I/O→Memory	SAR0 fixed, DAR0-1
1	0	0	0	Memory→Memory*	SAR0+1, DAR0 fixed
1	0	0	1	Memory→Memory*	SAR0-1, DAR0 fixed
1	0	1	0	reserved	
1	0	1	1	reserved	
1	1	0	0	Memory→I/O	SAR0+1, DAR0 fixed
1	1	0	1	Memory→I/O	SAR0-1, DAR0 fixed
1	1	1	0	reserved	
1	1	1	1	reserved	

\* includes memory mapped I/O

Table 11. Transfer Mode Combinations

**MMOD: Memory Mode Channel 0 (bit 1)**

When channel 0 is configured for memory to/from memory transfers, the external DREQ<sub>0</sub> input is not used to control the transfer timing. Instead, two automatic transfer timing modes are selectable - burst (MMOD = 1) and cycle steal (MMOD = 0). For burst memory to/from memory transfers, the DMAC takes control of the bus continuously until the DMA transfer completes (as shown by the byte count register = 0). In cycle steal mode, the CPU is given a cycle for each DMA byte transfer cycle until the transfer is completed.

For channel 0 DMA with I/O source or destination, the DREQ<sub>0</sub> input times the transfer and thus MMOD is ignored. MMOD is cleared to 0 during RESET.

**DMA/WAIT Control Register (DCNTL)**

DCNTL controls the insertion of wait states into DMAC (and CPU) accesses of memory or I/O. Also, the DMA request mode for each DREQ (DREQ<sub>0</sub> and DREQ<sub>1</sub>) input is defined as level or edge sense. DCNTL also sets the DMA transfer mode for channel 1, which is limited to memory to/from I/O transfers.

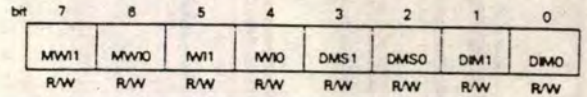

Figure 53. DMA/WAIT Control Register (DCNTL : I/O Address = 32H)

**MWI1, MWI0: Memory Wait Insertion (bits 7-6)**

Specifies the number of wait states introduced into CPU or DMAC memory access cycles. MWI1 and MWI0 are set to 1 during RESET. See section on Wait State Generator for details.

**IW1, IW0: I/O Wait Insertion (bits 5-4)**

Specifies the number of wait states introduced into CPU or DMAC I/O access cycles. IW1 and IW0 are set to 1 during RESET. See section on Wait State Generator for details.

**DMS1, DMS0: DMA Request Sense (bits 3-2)**

DMS1 and DMS0 specify the DMA request sense for channel 0 (DREQ<sub>0</sub>) and channel 1 (DREQ<sub>1</sub>), respectively. When reset to 0, the input is level sense. When set to 1, the input is edge sense. DMS1 and DMS0 are cleared to 0 during RESET.

**DIM1, DIM0: DMA Channel 1 I/O and Memory Mode (bits 1-0)**

Specifies the source/destination and address modifier for channel 1 memory to/from I/O transfer modes. DIM1 and DIM0 are cleared to 0 during RESET.

DIM1	DIM0	Transfer Mode	Address Increment/Decrement
0	0	Memory→I/O	MAR1+1, IAR1 fixed
0	1	Memory→I/O	MAR1-1, IAR1 fixed
1	0	I/O→Memory	IAR1 fixed, MAR1+1
1	1	I/O→Memory	IAR1 fixed, MAR1-1

Table 12: Channel 1 Transfer Mode

**DMA Operation**

This section discusses the three DMA operation modes for channel 0, memory to/from memory, memory to/from I/O, and memory to/from memory mapped I/O. In addition, the operation of channel 0 DMA with the on-chip ASCI (Asynchronous Serial Communication Interface) as well as Channel 1 DMA are described.

**Memory ↔ Memory - Channel 0**

For memory to/from memory transfers, the external DREQ<sub>0</sub> input is not used for DMA transfer timing. Rather,

the DMA operation is timed in one of two programmable modes - burst or cycle steal. In both modes, the DMA operation automatically proceeds until termination (shown by byte count - BCR0) = 0.

In burst mode, the DMA operation proceeds until termination. In this case, the CPU cannot perform any program execution until the DMA operation is completed.

In cycle steal mode, the DMA and CPU operation are alternated after each DMA byte transfer until the DMA is completed. The sequence...

1 CPU Machine Cycle  
DMA Byte Transfer

... is repeated until DMA is completed. Fig. 54. shows cycle steal mode DMA timing.

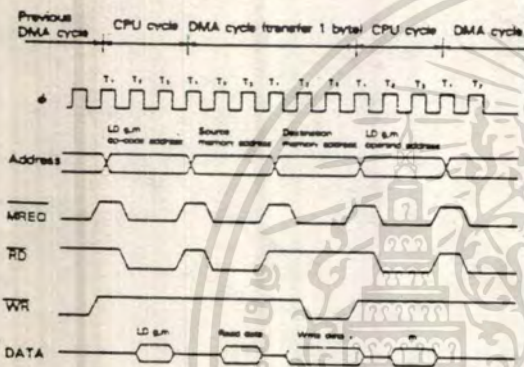

Figure 54. DMA Timing-Cycle Steal Mode

To initiate memory ↔ memory DMA transfer for channel 0, perform the following operations.

- (1) Load the memory source and destination address into SAR0 and DAR0.
- (2) Specify memory to/from memory mode and address increment/decrement in the SM0, SM1, DM0 and DM1 bits of DMODE.
- (3) Load the number of bytes to transfer in BCR0.
- (4) Specify burst or cycle steal mode in the MMOD bit of DCNTL.
- (5) Program DE0 = 1 (with DWE0 = 0 in the same access) in DSTAT and the DMA operation starts one machine cycle later. If interrupt occurs at the same time, the DIE0 bit should be set to 1.

Memory ↔ I/O (Memory Mapped I/O) - Channel 0

For memory ↔ I/O (and memory to/from memory mapped I/O) the DREQ0 input is used to time the DMA transfers. In addition, the TEND0 (Transfer End) output is used to indicate the last (byte count register BCR0 = 00H) transfer.

The DREQ0 input can be programmed as level or edge sensitive.

When level sense is programmed, the DMA operation begins when DREQ0 is sampled LOW. If DREQ0 is sampled HIGH, after the next DMA byte transfer, control is relinquished to the Z80180 CPU. As shown in Fig. 33, DREQ0 is sampled at the rising edge of the clock cycle prior to T3, i.e. either T2 or Tw.

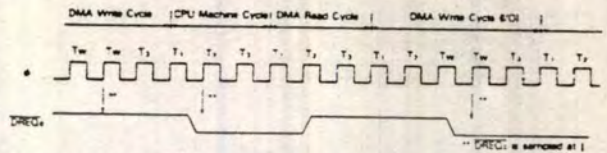

Figure 55. CPU Operation and DMA Operation (DREQ0 is Programmed for Level Sense)

When edge sense is programmed, DMA operation begins at the falling edge of DREQ0. If another falling edge is detected before the rising edge of the clock prior to T3 during DMA write cycle (i.e. T2 or Tw), the DMAC continues operating. If an edge is not detected, the CPU is given control after the current byte DMA transfer completes. The CPU will continue operating until a DREQ0 falling edge is detected before the rising edge of the clock prior to T2 at which time the DMA operation will (re)start. Fig. 56 shows the edge sense DMA timing.

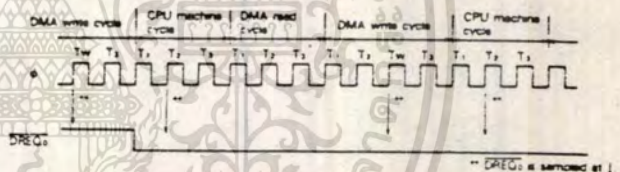

Figure 56. CPU Operation and DMA Operation (DREQ0 is Programmed for Edge Sense)

During the transfers for channel 0, the TEND0 output goes LOW synchronous with the write cycle of the last (BCR0 = 00H) DMA transfer (Reference Fig. 57).

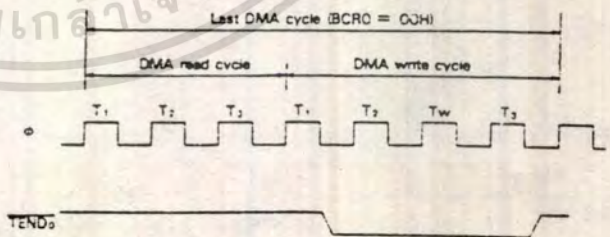

Figure 57. TEND0 Output Timing

The DREQ0 and TEND0 pins are programmably multiplexed with the CKA0 and CKA1 ASCi clock input/outputs. However, when DMA channel 0 is programmed for memory ↔ I/O (and memory ↔ memory mapped I/O) transfers, the CKA0/DREQ0 pin automatically functions as input pin even if it has been programmed as output pin for

CKA0. And the CKA1/ $\overline{\text{TEND}}_0$  pin functions as output pin for  $\overline{\text{TEND}}_0$  by setting CKA1D to 1 in CNTLA1.

To initiate memory  $\leftrightarrow$  I/O (and memory  $\leftrightarrow$  memory mapped I/O) DMA transfer for channel 0, perform the following operations:

(1) Load the memory and I/O or memory mapped I/O source and destination addresses into SAR0 and DAR0. Note that I/O addresses (not memory mapped I/O) are limited to 16 bits (A0-A15). Make sure that bits A16, A17 and A19 are 0 (A18 is a don't care) to correctly enable the external  $\overline{\text{DREQ}}_0$  input.

(2) Specify memory  $\leftrightarrow$  I/O or memory  $\leftrightarrow$  memory mapped I/O mode and address increment/decrement in the SM0, SM1, DM0, and DM1 bits of DMODE.

(3) Load the number of bytes to transfer in BCR0.

(4) Specify whether  $\overline{\text{DREQ}}_0$  is edge or level sense by programming the DMS0 bit of DCNTL.

(5) Enable or disable DMA termination interrupt with the DIE0 bit in DSTAT.

(6) Program DE0 = 1 (with DWE0 = 0 in the same access) in DSTAT and the DMA operation begins under the control of the  $\overline{\text{DREQ}}_0$  input.

#### Memory $\leftrightarrow$ ASCII - Channel 0

Channel 0 has extra capability to support DMA transfer to/from the on-chip two channel ASCII. In this case, the external  $\overline{\text{DREQ}}_0$  input is not used for DMA timing. Rather, the ASCII status bits are used to generate an internal  $\overline{\text{DREQ}}_0$ . The TDRE (Transmit Data Register Empty) bit and the RDRF (Receive Data Register Full) bit are used to generate an internal  $\overline{\text{DREQ}}_0$  for ASCII transmission and reception respectively.

To initiate memory  $\leftrightarrow$  ASCII DMA transfer, perform the following operations:

(1) Load the source and destination addresses into SAR0 and DAR0. Specify the I/O (ASCII) address as follows:

Bits A0-A7 should contain the address of the ASCII channel transmitter or receiver (I/O addresses 6H-9H).

Bits A8-A15 should equal 0.

Bits A17-A18 should be set according to Table 13 to enable use of the appropriate ASCII status bit as an internal DMA request.

SAR18	SAR17	SAR16	DMA Transfer Request
X	0	0	$\overline{\text{DREQ}}_0$
X	0	1	RDRF (ASCII channel 0)
X	1	0	RDRF (ASCII channel 1)
X	1	1	reserved

X: Don't care

DAR18	DAR17	DAR16	DMA Transfer Request
X	0	0	$\overline{\text{DREQ}}_0$
X	0	1	TDRE (ASCII channel 0)
X	1	0	TDRE (ASCII channel 1)
X	1	1	reserved

X: Don't care

Table 13: DMA Request

(2) Specify memory  $\leftrightarrow$  I/O transfer mode and address increment/decrement in the SM0, SM1, DM0 and DM1 bits of DMODE.

(3) Load the number of bytes to transfer in BCR0.

(4) The DMA request sense mode (DMS0 bit in DCNTL) MUST be specified as "edge sense".

(5) Enable or disable DMA termination interrupt with the DIE0 bit in DSTAT.

(6) Program DE0 = 1 (with DWE0 = 0 in the same access) in DSTAT and the DMA operation with the ASCII begins under control of the ASCII generated internal DMA request.

The ASCII receiver or transmitter using DMA is initialized to allow the first DMA transfer to begin.

The ASCII receiver must be "empty" as shown by RDRF = 0.

The ASCII transmitter must be "full" as shown by TDRE = 0. Thus, the first byte is written to the ASCII Transmit Data Register under program control. The remaining bytes are transferred using DMA.

**Channel 1 DMA.** DMAC Channel 1 performs memory to/from I/O transfers. Except for different registers and status/control bits, operation is exactly the same as described for channel 0 memory to/from I/O DMA.

To initiate DMA channel 1 memory  $\leftrightarrow$  I/O transfer perform the following operations:

(1) Load the memory address (20 bits) into MAR1.

(2) Load the I/O address (16 bits) into IAR1.

(3) Program the source/destination and address increment/decrement mode using the DIM1 and DIM0 bits in DCNTL.

(4) Specify whether  $\overline{DREQ1}$  is level or edge sense in the DMS1 bit in DCNTL.

(5) Enable or disable DMA termination interrupt with the DIE1 bit in DSTAT.

(6) Program DE1 = 1 (with  $\overline{DWE1}$  = 0 in the same access) in DSTAT and the DMA operation with the external I/O device begins using the external  $\overline{DREQ1}$  input and  $\overline{TEND1}$  output.

**DMA Bus Timing.** When memory (and memory mapped I/O) is specified as a source or destination,  $\overline{MREQ}$  goes LOW during the memory access. When I/O is specified as a source or destination,  $\overline{IORQ}$  goes LOW during the I/O access.

When I/O (and memory mapped I/O) is specified as a source or destination, the DMA timing is controlled by the external  $\overline{DREQ}$  input and the  $\overline{TEND}$  output indicates DMA termination. Note that external I/O devices may not overlap addresses with internal I/O and control registers, even using DMA.

For I/O accesses, one wait state is automatically inserted. Additional wait states can be inserted by programming the on-chip wait state generator, or using the external WAIT input. Note that for memory mapped I/O accesses, this automatic I/O wait state is not inserted.

For memory to memory transfers (channel 0 only), the external  $\overline{DREQ0}$  input is ignored. Automatic DMA timing is programmed as either burst or cycle steal.

When a DMA memory address carry/borrow between bits A15 and A16 of the address bus occurs (when crossing 64K byte boundaries), the minimum bus cycle is extended to 4 clocks by automatic insertion of one internal T1 state.

**DMAC Channel Priority.** For simultaneous  $\overline{DREQ0}$  and  $\overline{DREQ1}$  requests, channel 0 has priority over channel 1. When channel 0 is performing a memory to/from memory transfer, channel 1 cannot operate until the channel 0 operation has terminated. If channel 1 is operating, channel 0 cannot operate until channel 1 releases control of the bus.

**DMAC and BUSREQ, BUSACK.** The  $\overline{BUSREQ}$  and  $\overline{BUSACK}$  inputs allow another bus master to take control of the Z80180 bus.  $\overline{BUSREQ}$  and  $\overline{BUSACK}$  have priority over the on-chip DMAC and suspends DMAC operation. The DMAC releases the bus to the external bus master at the breakpoint of the DMAC memory or I/O access. Since a single byte DMAC transfer requires a read and a write cycle, it is possible for the DMAC to be suspended after the DMAC read, but before the DMAC write. Hence, when

the external master releases the Z80180 bus ( $\overline{BUSREQ}$  HIGH), the on-chip DMAC correctly continues the suspended DMA operation.

**DMAC Internal Interrupts.** Fig. 58 illustrates the internal DMA interrupt request generation circuit.

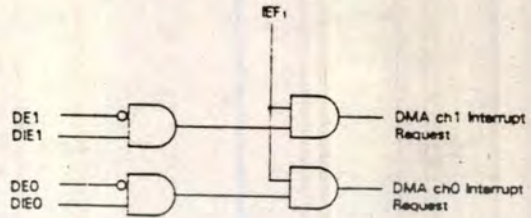

Figure 58. DMA Interrupt Request Generation

DE0 and DE1 are automatically cleared to 0 by the Z80180 at the completion (byte count = 0) of a DMA operation for channel 0 and channel 1, respectively. They remain 0 until a 1 is written. Since DE0 and DE1 use level sense, an interrupt occurs if the CPU IEF1 flag is set to 1. Therefore, the DMA termination interrupt service routine should disable further DMA interrupts (by programming the channel DIE bit = 0) before enabling CPU interrupts (i.e. IEF1 is set to 1). After reloading the DMAC address and count registers, the DIE bit can be set to 1 to reenable the channel interrupt, and at the same time DMA can resume by programming the channel DE bit = 1.

**DMAC and NMI.** NMI, unlike all other interrupts, automatically disables DMAC operation by clearing the DME bit of DSTAT. Thus, the NMI interrupt service routine responds to time critical events without delay due to DMAC bus usage. Also, NMI can be effectively used as an external DMA abort input, recognizing that both channels are suspended by the clearing of DME.

If the falling edge of NMI occurs before the falling clock of the state prior to T3 (T2 or Tw) of the DMA write cycle, the DMAC is suspended and the CPU starts the NMI response at the end of the current cycle.

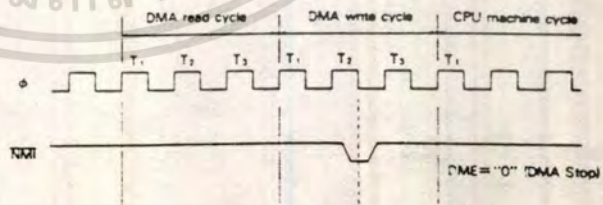

Figure 59. NMI and DMA Operation

By setting a channel's DE bit to 1, the channel's operation is restarted and DMA correctly resumes from its suspended point by NMI. (Reference Fig. 59)

**DMAC and RESET.** During RESET the bits in DSTAT, DMODE, and DCNTL are initialized as stated in their in-

dividual register descriptions. Any DMA operation in progress is stopped, allowing the CPU to use the bus to perform the RESET sequence. However, the address

register (SAR, DAR0, MAR1, IAR1) and byte count register (BCR0, BCR1) contents are not changed during RESET.

## Asynchronous Serial Communication Interface (ASCI)

The Z80180 on-chip ASCI has two independent full-duplex channels. Based on full programmability of the following functions, the ASCI directly communicates with a wide variety of standard UARTs (Universal Asynchronous Receiver/Transmitter) including the Z8440 SIO and the Z8530 SCC.

The key functions for ASCI are shown below. Each channel is independently programmable.

- Full-duplex communication.
- 7- or 8-bit data length.
- Program controlled 9th data bit for multiprocessor communication.
- 1 or 2 stop bits.
- Odd, even, no parity.
- Parity, overrun, framing error detection.
- Programmable baud rate generator, /16 and /64 modes.
- Speed to 38.4K bits per second (CPU  $f_c = 6.144$  MHz).
- Modem control signals - Channel 0 has  $\overline{DCD0}$ ,  $\overline{CTS0}$  and  $\overline{RTS0}$  Channel 1 has  $\overline{CTS1}$ .
- Programmable interrupt condition enable and disable.
- Operation with on-chip DMAC.

the ASCI Transmit Data Register (TDR), the data is shifted out to the TXA pin. When transmission is completed, the next byte (if available) is automatically loaded from TDR into TSR and the next transmission starts. If no data is available for transmission, TSR idles by outputting a continuous HIGH level. This register is not program accessible.

**ASCI Transmit Data Register 0, 1 (TDR0, 1: I/O Address = 06H, 07H)**

Data written to the ASCI Transmit Data Register is transferred to the TSR as soon as TSR is empty. Data can be written while TSR is shifting out the previous byte of data. Thus, the ASCI transmitter is double buffered.

Data can be written into and read from the ASCI Transmit Data Register.

If data is read from the ASCI Transmit Data Register, the ASCI data transmit operation will not be affected by this read operation.

**ASCI Receive Shift Register 0, 1 (RSR0, 1)**

This register receives data shifted in on the RXA pin. When full, data is automatically transferred to the ASCI Receive Data Register (RDR) if it is empty. If RSR is not empty when the next incoming data byte is shifted in, an overrun error occurs. This register is not program accessible.

**ASCI Receive Data Register 0, 1 (RDR0, 1: I/O Address = 08H, 09H)**

When a complete incoming data byte is assembled in RSR, it is automatically transferred to the RDR if RDR is empty. The next incoming data byte can be shifted into RSR while RDR contains the previous received data byte. Thus, the ASCI receiver is double buffered.

The ASCI Receive Data Register is a read-only-register. However, if  $RDRF = 0$ , data can be written into the ASCI Receive Data Register, and the data can be read.

**ASCI Status Register 0, 1 (STAT0, 1)**

Each channel status register allows interrogation of ASCI communication, error and modem control signal status, and enabling or disabling of ASCI interrupts.

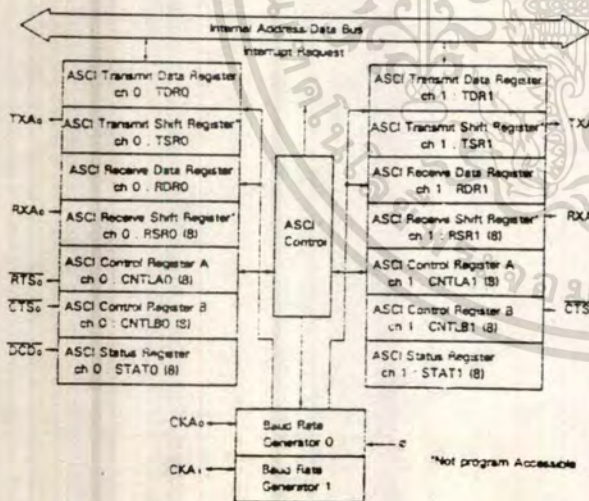

Figure 50. ASCI Block Diagram

**ASCI Register Description.** The following subparagraphs explain the various functions of the ASCI registers.

**ASCI Transmit Shift Register 0, 1 (TSR0, 1)**

When the ASCI Transmit Shift Register receives data from

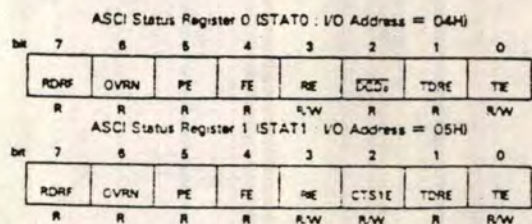

Figure 61. ASCI Status Registers

### RDRF: Receive Data Register Full (bit 7)

RDRF is set to 1 when an incoming data byte is loaded into RDR. Note that if a framing or parity error occurs, RDRF is still set and the receive data (which generated the error) is still loaded into RDR. RDRF is cleared to 0 by reading RDR, when the DCD<sub>0</sub> input is HIGH, in IOSTOP mode and during RESET.

### OVRN: Overrun Error (bit 6)

OVRN is set to 1 when RDR is full and RSR becomes full. OVRN is cleared to 0 when the EFR bit (Error Flag Reset) of CNTLA is written to 0, when DCD<sub>0</sub> is HIGH, in IOSTOP mode, and during RESET.

### PE: Parity Error (bit 5)

PE is set to 1 when a parity error is detected on an incoming data byte and ASCII parity detection is enabled (the MOD1 bit of CNTLA is set to 1). PE is cleared to 0 when the EFR bit (Error Flag Reset) of CNTLA is written to 0, when DCD<sub>0</sub> is HIGH, in IOSTOP mode, and during RESET.

### FE: Framing Error (bit 4)

If a receive data byte frame is delimited by an invalid stop bit (i.e. 0, should be 1), FE is set to 1. FE is cleared to 0 when the EFR bit (Error Flag Reset) of CNTLA is written to 0, when DCD<sub>0</sub> is HIGH, in IOSTOP mode, and during RESET.

### RIE: Receive Interrupt Enable (bit 3)

RIE should be set to 1 to enable ASCII receive interrupt requests. When RIE is 1, if any of the flags RDRF, OVRN, PE, or FE become set to 1, an interrupt request is generated. For channel 0, an interrupt is also generated by the transition of the external DCD<sub>0</sub> input from LOW to HIGH. RIE is cleared to 0 during RESET.

### DCD<sub>0</sub>: Data Carrier Detect (bit 2 STAT0)

Channel 0 has an external DCD<sub>0</sub> input pin. The DCD<sub>0</sub> bit is set to 1 when the DCD<sub>0</sub> input is HIGH. It is cleared to 0 on the first read of STAT0 following the DCD<sub>0</sub> input transition from HIGH to LOW and during RESET. When DCD<sub>0</sub> = 1, receiver unit is reset and receiver operation is inhibited.

### CTS1E: Channel 1 CTS Enable (bit 2 STAT1)

Channel 1 has an external CTS<sub>1</sub> input (pin 52) which is multiplexed with the receive data pin (RXS) for the CSI/O (Clocked Serial I/O Port). Setting CTS1E to 1 selects the CTS<sub>1</sub> function and clearing CTS1E to 0 selects the RXS function.

### TDRE: Transmit Data Register Empty (bit 1)

TDRE = 1 indicates that the TDR is empty and the next transmit data byte is written to TDR. After the byte is written to TDR, TDRE is cleared to 0 until the ASCII transfers the byte from TDR to the TSR and then TDRE is again set to 1. TDRE is set to 1 in IOSTOP mode and during RESET. When the external CTS<sub>1</sub> input is HIGH, TDRE is reset to 0.

### TIE: Transmit Interrupt Enable (bit 0)

TIE should be set to 1 to enable ASCII transmit interrupt re-

quests. If TIE = 1, an interrupt will be requested when TDRE = 1. TIE is cleared to 0 during RESET.

**ASCII Control Register A0, 1 (CNTLA0, 1).** Each ASCII channel Control Register A configures the major operating modes such as receiver/transmitter enable and disable, data format, and multiprocessor communication mode.

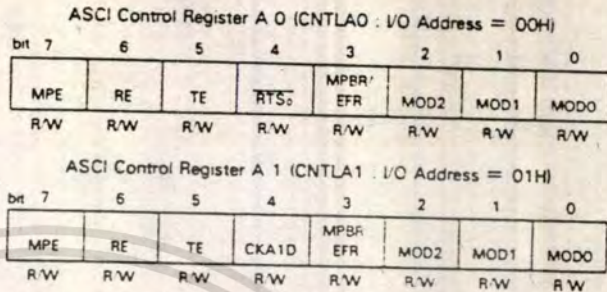

Figure 62. ASCII Control Register A

### MPE: Multi-Processor Mode Enable (bit 7)

The ASCII has a multiprocessor communication mode which utilizes an extra data bit for selective communication when a number of processors share a common serial bus. Multiprocessor data format is selected when the MP bit in CNTLB is set to 1. If multiprocessor mode is not selected (MP bit in CNTLB = 0), MPE has no effect. If multiprocessor mode is selected, MPE enables or disables the "wake-up" feature as follows. If MPE is set to 1, only received bytes in which the MPB (multiprocessor bit) = 1 can affect the RDRF and error flags. Effectively, other bytes (with MPB = 0) are "ignored" by the ASCII. If MPE is reset to 0, all bytes, regardless of the state of the MPB data bit, affect the REDR and error flags. MPE is cleared to 0 during RESET.

### RE: Receiver Enable (bit 6)

When RE is set to 1, the ASCII receiver is enabled. When RE is reset to 0, the receiver is disabled and any receive operation in progress is interrupted. However, the RDRF and error flags are not reset and the previous contents of RDRF and error flags are held. RE is cleared to 0 in IOSTOP mode during RESET.

### TE: Transmitter Enable (bit 5)

When TE is set to 1, the ASCII transmitter is enabled. When TE is reset to 0, the transmitter is disabled and any transmit operation in progress is interrupted. However, the TDRE flag is not reset and the previous contents of TDRE are held. TE is cleared to 0 in IOSTOP mode during RESET.

### RTS<sub>0</sub> - Request to Send Channel 0 (bit 4 in CNTLA0)

When RTS<sub>0</sub> is reset to 0, the RTS<sub>0</sub> output pin will go LOW. When RTS<sub>0</sub> is set to 1, the RTS<sub>0</sub> output immediately goes HIGH. RTS<sub>0</sub> is set to 1 during RESET.

### CKA1D: CKA1 Clock Disable (bit 4 in CNTLA1)

When CKA1D is set to 1, the multiplexed CKA1/TEND<sub>0</sub> pin (pin 50) is used for the TEND<sub>0</sub> function. When CKA1D =

0, the pin is used as CKA1, an external data clock input/output for channel 1. CKA1D is cleared to 0 during RESET.

**MPBR/EFR: Multiprocessor Bit Receive/Error Flag Reset (bit 3)**

When multiprocessor mode is enabled (MP in CNTLB = 1), MPBR, when read, contains the value of the MPB bit for the last receive operation. When written to 0, the EFR function is selected to reset all error flags (OVRN, FE and PE) to 0. MPBR/EFR is undefined during RESET.

**MOD2, 1, 0: ASCII Data Format Mode 2, 1, 0 (bits 2-0)**  
These bits program the ASCII data format as follows.

**MOD2**

- = 0 → 7 bit data
- = 1 → 8 bit data

**MOD1**

- = 0 → No parity
- = 1 → Parity enabled

**MOD0**

- = 0 → 1 stop bit
- = 1 → 2 stop bits

The data formats available based on all combinations of MOD2, MOD1 and MOD0 are shown in Table 14.

MOD2	MOD1	MOD0	Data Format
0	0	0	Start + 7 bit data + 1 stop
0	0	1	Start + 7 bit data + 2 stop
0	1	0	Start + 7 bit data + parity + 1 stop
0	1	1	Start + 7 bit data + parity + 2 stop
1	0	0	Start + 8 bit data + 1 stop
1	0	1	Start + 8 bit data + 2 stop
1	1	0	Start + 8 bit data + parity + 1 stop
1	1	1	Start + 8 bit data + parity + 2 stop

Table 14. Data Formats

**ASCII Control Register B0, 1 (CNTLB0, 1).** Each ASCII channel control register B configures multiprocessor mode, parity and baud rate selection.

ASCII Control Register B 0 (CNTLB0 : I/O Address = 02H)  
ASCII Control Register B 1 (CNTLB1 : I/O Address = 03H)

bit 7	6	5	4	3	2	1	0
MPBT	MP	CTS/ PS	PEO	DR	SS2	SS1	SS0
R/W	R/W	R/W	R/W	R/W	R/W	R/W	R/W

Figure 63. ASCII Control Register B

**MPBT: Multiprocessor Bit Transmit (bit 7)**

When multiprocessor communication format is selected (MP bit = 1), MPBT is used to specify the MPB data bit for transmission. If MPBT = 1, then MPB = 1 is transmitted. If MPBT = 0, then MPB = 0 is transmitted. MPBT state is undefined during and after RESET.

**MP: Multiprocessor Mode (bit 6)**

When MP is set to 1, the data format is configured for multiprocessor mode based on the MOD2 (number of data

bits) and MOD0 (number of stop bits) bits in CNTLA. The format is as follows.

Start bit + 7 or 8 data bits + MPB bit + 1 or 2 stop bits

Note that multiprocessor (MP = 1) format has no provision for parity. If MP = 0, the data format is based on MOD0, MOD1, MOD2, and may include parity. The MP bit is cleared to 0 during RESET.

**CTS/PS: Clear to Send/Prescale (bit 5)**

When read, CTS/PS reflects the state of the external CTS input. If the CTS input pin is HIGH, CTS/PS will be read as 1. Note that when the CTS input pin is HIGH, the TDRE bit is inhibited (i.e. held at 0). For channel 1, the CTS<sub>1</sub> input is multiplexed with RXS pin (Clocked Serial Receive Data). Thus, CTS/PS is only valid when read if the channel 1 CTS1E bit = 1 and the CTS<sub>1</sub> input pin function is selected. The read data of CTS/PS is not affected by RESET.

When written, CTS/PS specifies the baud rate generator prescale factor. If CTS/PS is set to 1, the system clock is prescaled by 30 while if CTS/PS is cleared to 0, the system clock is prescaled by 10. CTS/PS is cleared to 0 during RESET.

**PEO: Parity Even Odd (bit 4)**

PEO selects even or odd parity. PEO does not affect the enabling/disabling of parity (MOD1 bit of CNTLA). If PEO is cleared to 0, even parity is selected. If PEO is set to 1, odd parity is selected. PEO is cleared to 0 during RESET.

**DR: Divide Ratio (bit 3)**

DR specifies the divider used to obtain baud rate from the data sampling clock. If DR is reset to 0, divide by 16 is used, while if DR is set to 1, divide by 64 is used. DR is cleared to 0 during RESET.

**SS2, 1, 0: Source/Speed Select 2, 1, 0 (bits 2-0)**

Specify the data clock source (internal or external) and baud rate prescale factor. SS2, SS1, SS0 are all set to 1 during RESET. Table 15 shows the divide ratio corresponding to SS2, SS1 and SS0.

The external ASCII channel 0 data clock pins are multiplexed with DMA control lines (CKA0/DRE<sub>Q</sub> and CKA1/TEND<sub>0</sub>). During RESET, these pins are initialized as ASCII data clock inputs. If SS2, SS1 and SS0 are reprogrammed (any other value than SS2, SS1, SS0 = 1) these pins become ASCII data clock outputs. However, if DMAC channel 0 is configured to perform memory to/from I/O (and memory mapped I/O) transfers the CKA0/DRE<sub>Q</sub> pin reverts to DMA control signals regardless of SS2, SS1, SS0 programming. Also, if the CKA1D bit in the CNTLA register is set to 1, then the CKA1/TEND<sub>0</sub> reverts to the DMA Control output function regardless of SS2, SS1 and SS0 programming.

SS2	SS1	SS0	Divide Ratio
0	0	0	+ 1
0	0	1	+ 2
0	1	0	+ 4
0	1	1	+ 8
1	0	0	+ 16
1	0	1	+ 32
1	1	0	+ 64
1	1	1	external clock

Table 15. Divide Ratio

Final data clock rates are based on  $\overline{CTS}/PS$  (prescale), DR, SS2, SS1, SS0 and the Z80180 system clock frequency (Reference Table 16).

**MODEM Control Signals.** ASCII channel 0 has  $\overline{CTS}_0$ ,  $\overline{DCD}_0$ , and  $\overline{RTS}_0$  external modem control signals. ASCII channel 1 has a  $\overline{CTS}_1$  modem control signal which is multiplexed with RXS (Clock Serial Receive Data).

**$\overline{CTS}_0$ : Clear to Send 0 (Input).** The  $\overline{CTS}_0$  input allows external control (start/stop) of ASCII channel 0 transmit operations. When  $\overline{CTS}_0$  is HIGH, channel 0 TDRE bit is held at 0 whether or not the TDR0 (Transmit Data Register) is full or empty. When  $\overline{CTS}_0$  is LOW, TDRE reflects the state of TDR0. Note that the actual transmit operation is not disabled by  $\overline{CTS}_0$  HIGH, only TDRE is inhibited.

**$\overline{DCD}_0$ : Data Carrier Detect 0 (Input).** The  $\overline{DCD}_0$  input allows external control (start/stop) of ASCII channel 0 receive operations. When  $\overline{DCD}_0$  is HIGH, channel 0 RDRF bit is held at 0 whether or not the RDR0 (Receive Data Register) is full or empty. The error flags (PE, FE, and OVRN bits) are also held at 0. Even after the  $\overline{DCD}_0$  input goes LOW, these bits will not resume normal operation until the status register (STAT0) is read. Note that this first read of STAT0, while enabling normal operation, still indicates the  $\overline{DCD}_0$  input is HIGH ( $\overline{DCD}_0$  bit = 1) even though it has gone LOW. Thus, the STAT0 register should be read twice to insure the  $\overline{DCD}_0$  bit is reset to 0.

**$\overline{RTS}_0$ : Request to Send 0 (output).**  $\overline{RTS}_0$  allows the ASCII to control (start/stop) another communication devices transmission (e.g., by connection to that device's  $\overline{CTS}$  input).  $\overline{RTS}_0$  is essentially a 1 bit output port, having no side effects on other ASCII registers or flags.

**$\overline{CTS}_1$ : Clear to Send 1 (Input).** Channel 1  $\overline{CTS}_1$  input is multiplexed with RXS (Clock Serial Receive Data). The  $\overline{CTS}_1$  function is selected when the CTS1E bit in STAT1 is set to 1. When enabled, the  $\overline{CTS}_1$  operation is equivalent to  $\overline{CTS}_0$ .

Modem control signal timing is shown in Fig. 64 and Fig. 65.

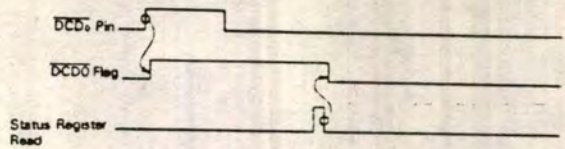

Figure 64.  $\overline{DCD}_0$  Timing

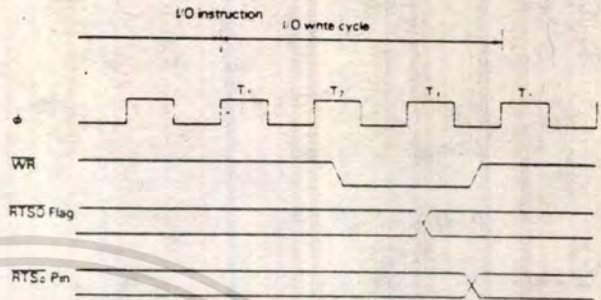

Figure 65.  $\overline{RTS}_0$  Timing

Fig. 66 shows the ASCII interrupt request generation circuit.

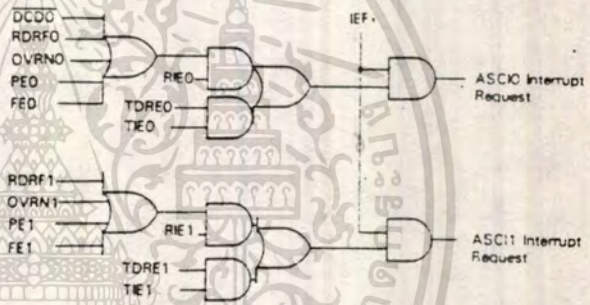

Figure 66. ASCII Interrupt Request Circuit Diagram

**ASCII ↔ DMAC Operation.** Operation of the ASCII with the on-chip DMAC channel 0 requires that the DMAC be correctly configured to use the ASCII flags as DMA request signals.

**ASCII and RESET.** During RESET, the ASCII status and control registers are initialized as defined in the individual register descriptions.

Receive and Transmit operations are stopped during RESET. However, the contents of the transmit and receive data registers (TDR and RDR) are not changed by RESET.

**ASCII Clock**

When in external clock input mode, the external clock is directly input to the sampling rate (+16/+64) as shown in Figure 67.

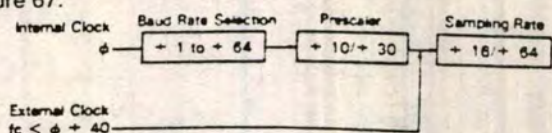

Figure 67.

Prescaler		Sampling Rate		Baud Rate				General Divide Ratio	Baud Rate (Example) (BPS)			CKA	
PS	Divide Ratio	DR	Rate	SS2	SS1	SS0	Divide Ratio		$\phi = 6.144$ MHz	$\phi = 4.608$ MHz	$\phi = 3.072$ MHz	I/O	Clock Frequency
0	$\phi + 10$	0	16	0	0	0	+1	$\phi + 160$	35400	19200	19200	0	$\phi + 10$
				0	0	1	2	320	19200	9600	20		
				0	1	0	4	640	9600	4800	40		
				0	1	1	8	1280	4800	2400	80		
				1	0	0	16	2560	2400	1200	160		
				1	0	1	32	5120	1200	600	320		
		1	1	0	64	10240	600	300	640				
		1	1	1	-	$fc + 16$	-	-	-	I	$fc$		
		1	64	0	0	0	+1	$\phi + 640$	9600	4800	4800	0	$\phi + 10$
				0	0	1	2	1280	4800	2400	20		
				0	1	0	4	2560	2400	1200	40		
				0	1	1	8	5120	1200	600	80		
1	0			0	16	10240	600	300	160				
1	0			1	32	20480	300	150	320				
1	1	0	64	40960	150	75	640						
1	1	1	-	$fc + 64$	-	-	-	I	$fc$				
1	$\phi + 30$	0	16	0	0	0	+1	$\phi + 480$	9600	4800	4800	0	$\phi + 30$
				0	0	1	2	960	4800	2400	60		
				0	1	0	4	1920	2400	1200	120		
				0	1	1	8	3840	1200	600	240		
				1	0	0	16	7680	600	300	480		
				1	0	1	32	15360	300	150	960		
		1	1	0	64	30720	150	75	1920				
		1	1	1	-	$fc + 16$	-	-	-	I	$fc$		
		1	64	0	0	0	+1	$\phi + 1920$	2400	1200	1200	0	$\phi + 30$
				0	0	1	2	3840	1200	600	60		
				0	1	0	4	7680	600	300	120		
				0	1	1	8	15360	300	150	240		
1	0			0	16	30720	150	75	480				
1	0			1	32	61440	75	37.5	960				
1	1	0	64	122880	37.5	18.75	1920						
1	1	1	-	$fc + 64$	-	-	-	I	$fc$				

Table 16. Baud Rate Selection

### Clocked Serial I/O Port (CSI/O)

The Z80180 includes a simple, high speed clock, synchronous serial I/O port. The CSI/O includes transmit/receive (half-duplex), fixed 8-bit data, and internal or external data clock selection. High speed operation (baud rate 200K bits/second at  $fc = 4$  MHz) is provided. The CSI/O is ideal for implementing a multiprocessor communication link between multiple Z80180s. These secondary devices may typically perform a portion of the system I/O processing, i.e. keyboard scan/decode, LDC interface, etc.

**CSI/O Block Diagram.** The CSI/O block diagram is shown in Fig. 68. The CSI/O consists of two registers - the Transmit/Receive Data Register (TRDR) and Control Register (CNTR).

**CSI/O Transmit/Receive Data Register (TRDR: I/O Address = 0BH).** TRDR is used for both CSI/O transmission and reception. Thus, the system design must insure that the constraints of half-duplex operation are met (Transmit and receive operation cannot occur simultaneously). For example, if a CSI/O transmission is attempted while the CSI/O is receiving data, a CSI/O will not work. Also note that TRDR is not buffered. Therefore, attempting to perform a CSI/O transmit while the previous transmit data is still being shifted out causes the shift data to be immediate-

ly updated, thereby corrupting the transmit operation in progress. Similarly, reading TRDR while a transmit or receive is in progress should be avoided.

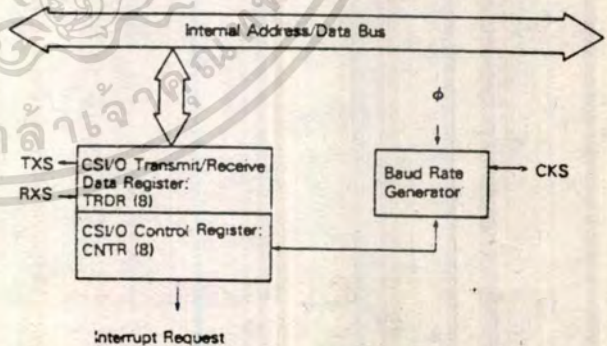

Figure 68. CSI/O Block Diagram

#### CSI/O Register Description

**CSI/O Control/Status Register (CNTR: I/O Address = 0AH).** CNTR is used to monitor CSI/O status, enable and disable the CSI/O, enable and disable interrupt generation, and select the data clock speed and source.

bit	7	6	5	4	3	2	1	0
	EF	EIE	RE	TE	-	SS2	SS1	SS0
	R	R/W	R/W	R/W		R/W	R/W	R/W

Figure 69. CSI/O Control Register

**EF: End Flag (bit 7)**

EF is set to 1 by the CSI/O to indicate completion of an 8-bit data transmit or receive operation. If EIE (End Interrupt Enable) bit = 1 when EF is set to 1, a CPU interrupt request is generated. Program access of TRDR only occurs if EF = 1. The CSI/O clears EF to 0 when TRDR is read or written. EF is cleared to 0 during RESET and IOSTOP mode.

**EIE: End Interrupt Enable (bit 6)**

EIE is set to 1 to enable EF = 1 to generate a CPU interrupt request. The interrupt request is inhibited if EIE is reset to 0. EIE is cleared to 0 during RESET.

**RE: Receive Enable (bit 5)**

A CSI/O receive operation is started by setting RE to 1. When RE is set to 1, the data clock is enabled. In internal clock mode, the data clock is output from the CKS pin. In external clock mode, the clock is input on the CKS pin. In either case, data is shifted in on the RXS pin in synchronization with the (internal or external) data clock. After receiving 8 bits of data, the CSI/O automatically clears RE to 0, EF is set to 1, and an interrupt (if enabled by EIE = 1) is generated. RE and TE are never both set to 1 at the same time. RE is cleared to 0 during RESET and IOSTOP mode.

Note that RXS (pin 52) is multiplexed with CTS1 modem control input of ASCII channel 1. In order to enable the RXS function, the CTS1E bit in CNTR1 should be reset to 0.

**Transmit Enable (bit 4)**

A CSI/O transmit operation is started by setting TE to 1. When TE is set to 1, the data clock is enabled. When in internal clock mode, the data clock is output from the CKS pin. In external clock mode, the clock is input on the CKS pin. In either case, data is shifted out on the TXS pin in synchronous with the (internal or external) data clock. After transmitting 8 bits of data, the CSI/O automatically clears TE to 0, EF is set to 1, and an interrupt (if enabled by EIE = 1) is generated. TE and RE are never both set to 1 at the same time. TE is cleared to 0 during RESET and IOSTOP mode.

**SS2, 1, 0: Speed Select 2, 1, 0 (bits 2-0)**

SS2, SS1 and SS0 select the CSI/O transmit/receive clock source and speed. SS2, SS1 and SS0 are all set to 1 during RESET. Table 17 shows CSI/O Baud Rate Selection.

SS2	SS1	SS0	Divide Ratio	Baud Rate
0	0	0	+ 20	(200000)
0	0	1	+ 40	(100000)
0	1	0	+ 80	(50000)
0	1	1	+ 160	(25000)
1	0	0	+ 320	(12500)
1	0	1	+ 640	(6250)
1	1	0	+ 1280	(3125)
1	1	1	external Clock input (less than + 20)	

( ) shows the baud rate (BPS) at  $\phi = 4$  MHz.

Table 17. CSI/O Baud Rate Selection

After RESET, the CKS pin is configured as an external clock input (SS2, SS1, SS0 = 1). Changing these values causes CKS to become an output pin and the selected clock is output when transmit or receive operations are enabled.

**CSI/O Interrupts.** The CSI/O interrupt request circuit is shown in Fig. 70.

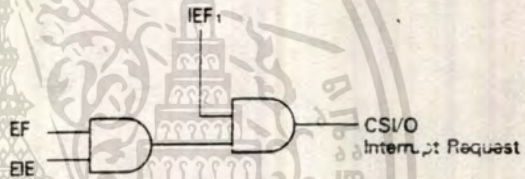

Figure 70. CSI/O Interrupt Request Generation

CSI/O operation. The CSI/O is operated using status polling or interrupt driven algorithms.

**Transmit - Polling**

1. Poll the TE bit in CNTR until TE = 0.
2. Write the transmit data into TRDR.
3. Set the TE bit in CNTR to 1.
4. Repeat 1 to 3 for each transmit data byte.

**Transmit - Interrupts**

1. Poll the TE bit in CNTR until TE = 0.
2. Write the first transmit data byte into TRDR.
3. Set the TE and EIE bits in CNTR to 1.

4. When the transmit interrupt occurs, write the next transmit data byte into TRDR.

5. Set the TE bit in CNTR to 1.

6. Repeat 4 to 5 for each transmit data byte.

### Receive - Polling

1. Poll the RE bit in CNTR until RE = 0.

2. Set the RE bit in CNTR to 1.

3. Poll the RE bit in CNTR until RE = 0.

4. Read the receive data from TRDR.

5. Repeat 2 to 4 for each receive data byte.

### Receive - Interrupts

1. Poll the RE bit in CNTR until RE = 0.

2. Set the RE and EIE bits in CNTR to 1.

3. When the receive interrupt occurs read the receive data from TRDR.

4. Set the RE bit in CNTR to 1.

5. Repeat 3 to 4 for each receive data byte.

### CSI/O Operation Timing Notes

(1) Transmitter clocking and receiver sampling timings are different from internal and external clocking modes. Fig. 71 to Fig. 74 show CSI/O Transmit/Receive Timing.

(2) The transmitter and receiver is disabled (TE and RE = 0) when initializing or changing the baud rate.

### CSI/O Operation Notes

(1) Disable the transmitter and receiver (TE and RE = 0) before initializing or changing the baud rate. When changing the baud rate after completion of transmission or reception, a delay of at least one bit time is required before baud rate modification.

(2) When RE or TE is cleared to 0 by software, a corresponding receive or transmit operation is immediately terminated. Normally, TE or RE is only cleared to 0 when EF = 1.

(3) Simultaneous transmission and reception is not possible. Thus, TE and RE are not both 1 at the same time.

CSI/O and RESET. During RESET each bit in the CNTR is initialized as defined in the CNTR register description.

CSI/O transmit and receive operations in progress are aborted during RESET. However, the contents of TRDR are not changed.

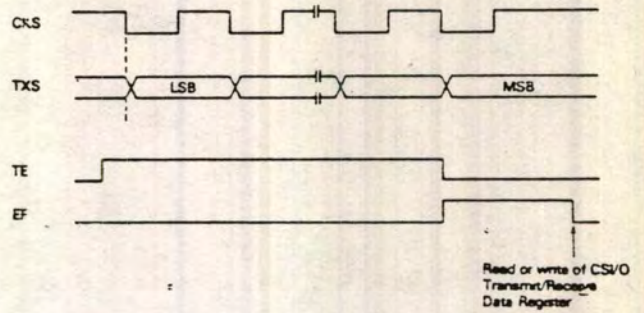

Figure 71. Transmit Timing-internal Clock

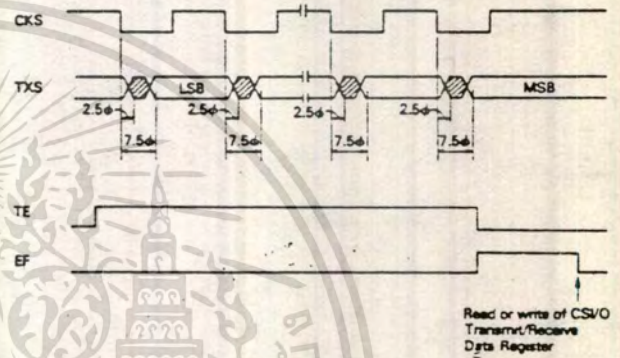

Figure 72. Transmit Timing-External Clock

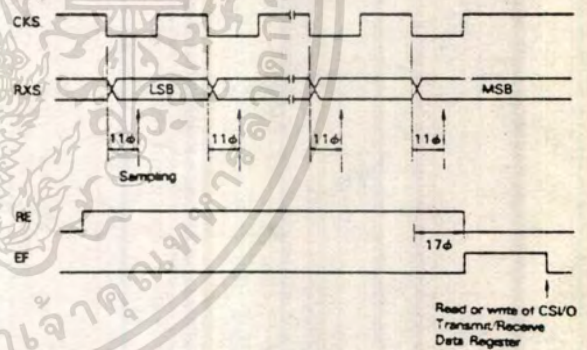

Figure 73. Receive Timing-Internal Clock

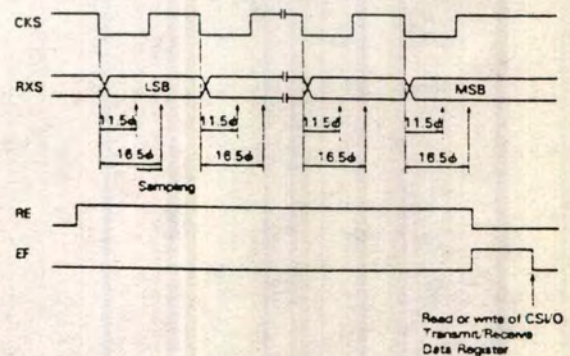

Figure 74. Receive Timing-External Clock

## Programmable Reload Timer (PRT)

The Z80180 contains a two channel 16-bit Programmable Reload Timer. Each PRT channel contains a 16-bit down counter and a 16-bit reload register. The down counter is directly read and written and a down counter overflow interrupt can be programmably enabled or disabled. Also, PRT channel 1 has a TOUT output pin (pin 31 - multiplexed with A18) which can be set HIGH, LOW, or toggled. Thus, PRT1 can perform programmable output waveform generation.

**PRT block diagram.** The PRT block diagram is shown in Fig. 75. The two channels have separate timer data and reload registers and a common status/control register. The PRT input clock for both channels is equal to the system clock divided by 20.

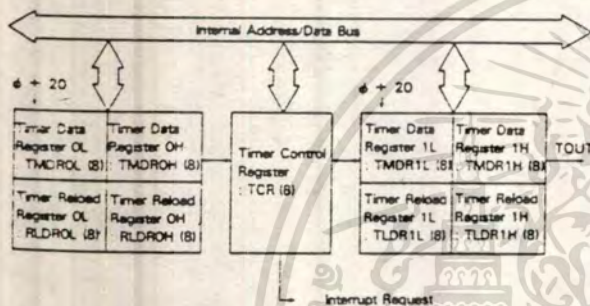

Figure 75. PRT Block Diagram

**PRT Register Description.** Timer Data Register (TMDR: I/O Address - CH0, ODH, OCH, CH1: 15H, 14H). PRT0 and PRT1 each have 16-bit Timer Data Registers (TMDR). TMDR0 and TMDR1 are each accessed as low and high byte registers (TMDR0H, TMDR0L and TMDR1H, TMDR1L). During RESET, TMDR0 and TMDR1 are set to FFFFH.

TMDR is decremented once every twenty clocks. When TMDR counts down to 0, it is automatically reloaded with the value contained in the Reload Register (RLDR).

TMDR is read and written by software using the following procedures. The read procedure uses a PRT internal temporary storage register to return accurate data without requiring the timer to be stopped. The write procedure requires the PRT to be stopped.

For reading (without stopping the timer), TMDR is read in the order of lower byte - higher byte (TMDRnL, TMDRnH). The lower byte read (TMDRnL) stores the higher byte value in an internal register. The following higher byte read (TMDRnH) accesses this internal register. This procedure insures timer data validity by eliminating the problem of potential 16-bit timer updating between each 8-bit read. Specifically, reading TMDR in higher byte - lower byte order may result in invalid data. Note the implications of TMDR higher byte internal storage for applications which may read only the lower and/or higher bytes. In normal

operation all TMDR read routines should access both the lower and higher bytes, in that order. For writing, the TMDR down counting must be inhibited using the TDE (Timer Down Count Enable) bits in the TCR (Timer Control Register). Then, any or both higher and lower bytes or TMDR can be freely written (and read) in any order.

**Timer Reload Register (RLDR: I/O Address = CH0, OEH, OFH, CH1: 16H, 17H).** PRT0 and PRT1 each have 16-bit Timer Reload Registers (RLDR). RLDR0 and RLDR1 are each accessed as low and high byte registers (RLDR0H, RLDR0L and RLDR1H, RLDR1L). During RESET, RLDR0 and RLDR1 are set to FFFFH.

When the TMDR counts down to 0, it is automatically reloaded with the contents of RLDR.

**Timer Control Register (TCR).** TCR monitors both channels (PRT0, PRT1) TMDR status. It also controls enabling and disabling of down counting and interrupts along with controlling output pin A18/TOUT for PRT1.

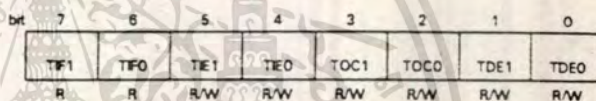

Figure 76. Timer Control Register (TCR: I/O Address = 10 H)

**TIF1: Timer Interrupt Flag 1 (bit 7).** When TMDR1 decrements to 0, TIF1 is set to 1. This generates an interrupt request if enabled by TIE1 = 1. TIF1 is reset to 0 when TCR is read and the higher or lower byte of TMDR1 is read. During RESET, TIF1 is cleared to 0.

**TIF0: Timer Interrupt Flag 0 (bit 6).** When TMDR0 decrements to 0, TIF0 is set to 1. This generates an interrupt request if enabled by TIE0 = 1. TIF0 is reset to 0 when TCR is read and the higher or lower byte of TMDR0 is read. During RESET, TIF0 is cleared to 0.

**TIE1: Timer Interrupt Enable 1 (bit 5).** When TIE1 is set to 1, TIF1 = 1 generates a CPU interrupt request. When TIE1 is reset to 0, the interrupt request is inhibited. During RESET, TIE1 is cleared to 0.

**TIE0: Timer Interrupt Enable 0 (bit 4).** When TIE0 is set to 1, TIF0 = 1 generates a CPU interrupt request. When TIE0 is reset to 0, the interrupt request is inhibited. During RESET, TIE0 is cleared to 0.

**TOC1, 0: Timer Output Control (bits 3, 2).** TOC1 and TOC0 control the output of PRT1 using the multiplexed A18/TOUT pin as shown in Table 18. During RESET, TOC1 and TOC0 are cleared to 0. This selects the address function for A18/TOUT. By programming TOC1 and TOC0, the A18/TOUT pin can be forced HIGH, LOW, or toggled when TMDR1 decrements to 0.

TOC1	TOC0	OUTPUT
0	0	Inhibited (A18/TOUT pin is selected as an address output function.)
0	1	toggled* (A18/TOUT pin is selected as a PRT1 output function.)
1	0	
1	1	

Table 18: Timer Output Control

TDE1, 0: Timer Down Count Enable (bits 1, 0). TDE1 and TDE0 enable and disable down counting for TMDR1 and TMDR0, respectively. When TDEn (n = 0, 1) is set to 1, down counting is executed for TMDRn. When TDEn is reset to 0, down counting is stopped and TMDRn is freely read or written. TDE1 and TDE0 are cleared to 0 during RESET and TMDRn will not decrement until TDEn is set to 1.

Fig. 77 shows timer initialization, count down, and reload timing. Fig. 78 shows timer output (A18/TOUT) timing.

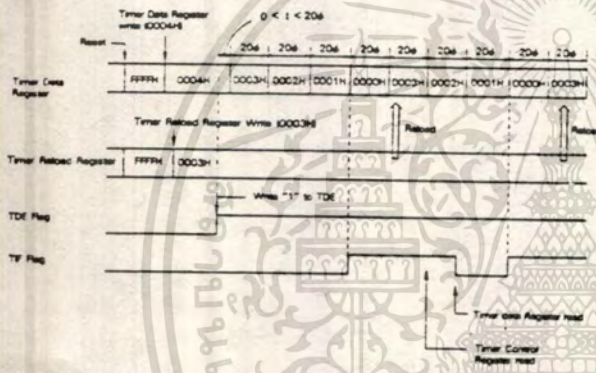

Figure 77. Timer Initialization, Count Down, and Reload Timing

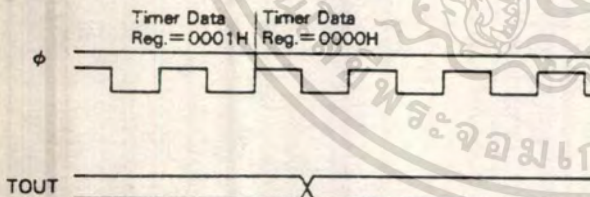

Figure 78. Timer Output Timing

PRT Interrupts. The PRT interrupt request circuit is shown in Fig. 79.

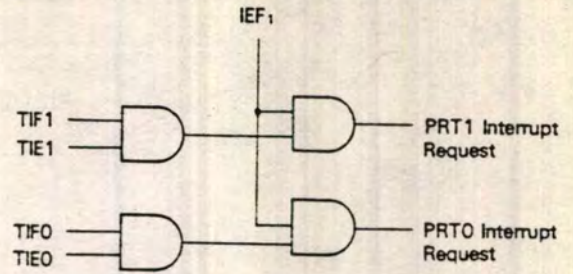

Figure 79. PRT Interrupt Request Generation

PRT and RESET. During RESET, the bits in TCR are initialized as defined in the TCR register description. Down counting is stopped and the TMDR and RLDR registers are initialized to FFFFH. The A18/TOUT pin reverts to the address output function.

#### PRT Operation Notes.

(1) TMDR data is accurately read without stopping down counting by reading the lower (TMDRnL\*) and higher (TMDRnH\*) bytes in that order. Also, TMDR is read or written by stopping the down counting.

(2) Care should be taken to insure that a timer reload does not occur during or between lower (RLDRnL\*) and higher (RLDRnH\*) byte writes. This may be guaranteed by system design/timing or by stopping down counting (with TMDR containing a non-zero value) during the RLDR updating. Similarly, in applications where TMDR is written at each TMDR overflow, the system/software design should guarantee that RLDR can be updated before the next overflow occurs. Otherwise, time base inaccuracy will occur.

Note: \*n = 0, 1

(3) During RESET, the multiplexed A18/TOUT pin reverts to the address output. By reprogramming the TOC1 and TOC0 bits, the timer output function for PRT channel 1 is selected. The following shows the initial state of the TOUT pin after TOC1 and TOC0 are programmed to select the PRT channel 1 timer output function.

(i) PRT (channel 1) has not counted down to 0. If the PRT has not counted down to 0 (timed out), the initial state of TOUT depends on the programmed value in TOC1 and TOC0.

## Secondary Bus Interface

E clock Output Timing. The Z80180 also has a secondary bus interface that allows it to easily interface with other peripheral families.

These devices require connection with the Z80180 synchronous E clock output. The speed (access time) required for the peripheral devices are determined by the Z80180 clock rate. Table 19, and Figures 80-82 define E clock output timing.

Wait states are inserted in op-code fetch, memory read/write, and I/O read/write cycles which extend the duration of E clock output HIGH. During I/O read/write cycles with no wait states (only occurs during on-chip I/O register accesses), E will not go HIGH.

Condition	Duration of E Clock Output "High"
Op-code Fetch Cycle	$T_2  - T_3 $ $(1.5\phi + n_w \cdot \phi)$
Memory Read/Write Cycle	$T_2  - T_3 $ $(0.5\phi + n_w \cdot \phi)$
I/O read Cycle	$1st\ T_w  - T_3 $ $(n_w \cdot \phi)$
I/O Write Cycle	$1st\ T_w  - T_3 $ $(n_w \cdot \phi)$
NMI Acknowledge 1st MC	$T_2  - T_3 $ $(1.5\phi)$
INT <sub>0</sub> Acknowledge 1st MC	$1st\ T_w  - T_3 $ $(0.5\phi + n_w \cdot \phi)$
BUS RELEASE mode	$\phi  - \phi $ $(2\phi\ or\ 1\phi)$
SLEEP mode	
SYSTEM STOP mode	

NOTE)  $n_w$  : the number of wait states  
MC : Machine Cycle

Table 19. E Clock Timing in Each Condition

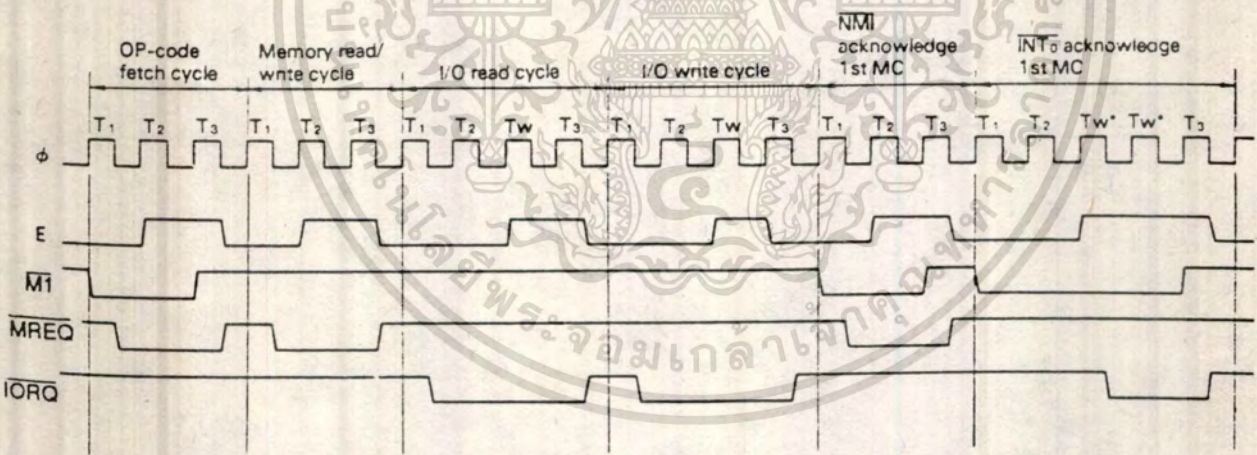

\* Two wait states are automatically inserted.

NOTE) MC: Machine Cycle

Figure 80. E Clock Timing (During Read/Write Cycle and Interrupt Acknowledge Cycle)

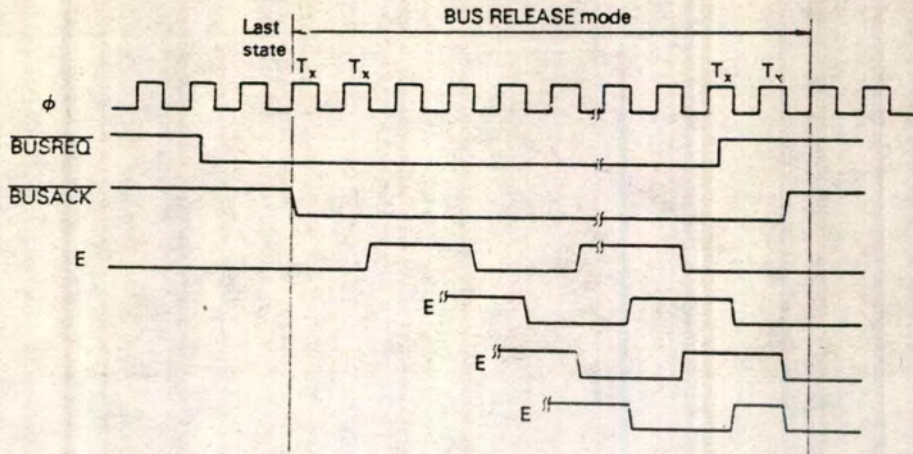

Figure 81. E Clock Timing in BUS RELEASE Mode

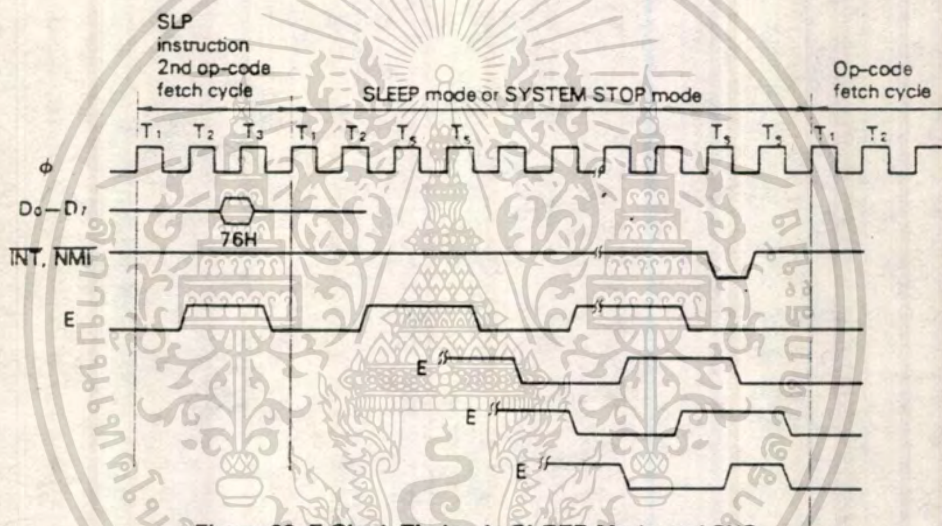

Figure 82. E Clock Timing in SLEEP Mode and SYSTEM STOP Mode

### On-Chip Clock Generator

The Z80180 contains a crystal oscillator and system clock generator. A crystal can be directly connected or an external clock input can be provided. In either case, the system clock is equal to one-half the input clock. For example, a crystal or external clock input of 8 MHz corresponds with a system clock rate of 4 MHz.

If an external clock input is used instead of a crystal, the waveform (twice the clock rate) should exhibit a  $50\% \pm 10\%$  duty cycle. Note that the minimum clock input HIGH voltage level is  $V_{cc}-0.6V$ . The external clock input is connected to the EXTAL pin, while the XTAL pin is left open. Fig. 83 shows external clock interface.

The following table shows the AT cut crystal characteristics ( $C_0$ ,  $R_s$ ) and the load capacitance ( $CL_1$ ,  $CL_2$ ) required for various frequencies of Z80180 operation.

Clock frequency	4MHz	$4MHz < f \leq 12MHz$	$12MHz < f \leq 16MHz$
$C_0$	$< 7 \text{ pf}$	$< 7 \text{ pf}$	$< 7 \text{ pf}$
$R_s$	$< 50 \Omega$	$< 60 \Omega$	$< 60 \Omega$
$CL_1, CL_2$	10 to 22 pf $\pm 10\%$	10 to 22 pf $\pm 10\%$	10 to 22 pf $\pm 10\%$

Table 20.

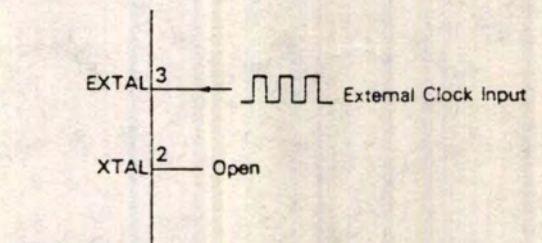

Figure 83. External Clock Interface

Fig. 84 shows the Z80180 clock generator circuit while Fig. 85 and Fig. 86 specify circuit board design rules.

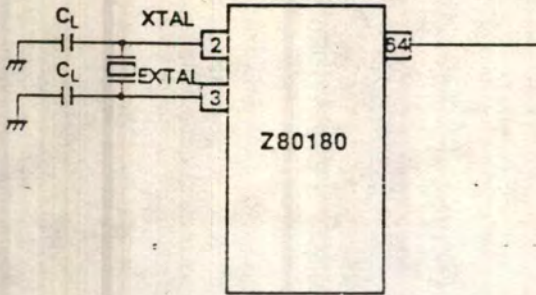

Figure 84. Clock Generator Circuit

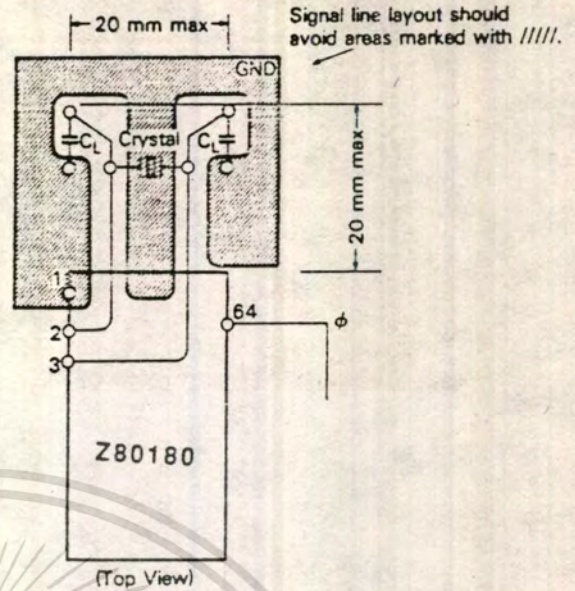

Figure 86. Example of Board Design

Circuit Board design should observe the following.

(1) To prevent induced noise, the crystal and load capacitors should be physically located as close to the LSI as possible.

(2) Signal lines should not run parallel to the clock oscillator inputs. In particular, the clock input circuitry and the system clock output (pin 64) should be separated as much as possible.

(3) Similar to (2), Vcc power lines should be separated from the clock oscillator input circuitry.

(4) Resistivity between XTAL or EXTAL and the other pins should be greater than 10M ohms.

Signal line layout should avoid areas marked with // // // //.

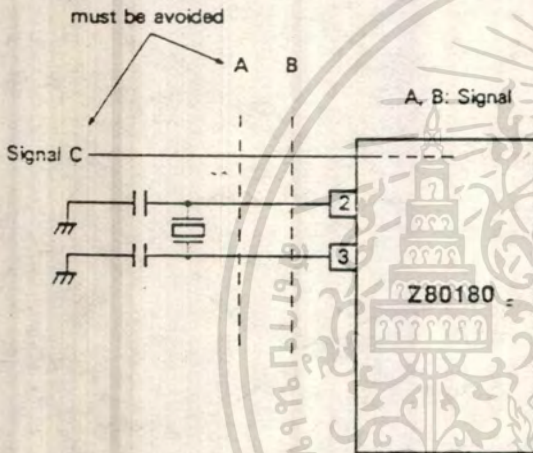

Figure 85. Circuit Board Design Rules

## Miscellaneous

Free Running Counter (I/O Address = 18H)

Read only 8-bit free running counter without control registers and status registers. The contents of the 8-bit free running counter is counted down by one with an interval of 10 clock cycles. The free running counter continues counting down without being affected by the read operation.

If data is written into the free running counter, the interval of DRAM refresh cycle and baud rates for the ASCII and CSI/O are not guaranteed.

In IOSTOP mode, the free running counter continues counting down. It is initialized to FFH during RESET.

## SOFTWARE ARCHITECTURE

Instruction Set. The Z80180 is object code compatible with the Z80 CPU, refer to the Z80 CPU Technical Manual or the Z80 Assembly Language Programming Manual for further details.

New Instructions	Operation
SLP	Enter SLEEP mode
MLT	8-bit multiply with 16-bit result
INO g, (m)	Input contents of immediate I/O address
OUT0 (m), g	Output register contents to immediate I/O address
OTIM	Block output - increment
OTIMR	Block output - increment and repeat
OTDM	Block output - decrement
OTDMR	Block output - decrement and repeat
TSTIO m	Non-destructive AND, I/O port, and accumulator
TST g	Non-destructive AND, register, and accumulator
TST m	Non-destructive AND, immediate data and accumulator.
TST (HL)	Non-destructive AND, memory data, and accumulator.

**SLP - Sleep.** The SLP instruction causes the Z80180 to enter the SLEEP low power consumption mode. See section 2.4 for a complete description of the SLEEP state.

**MLT - Multiply.** The MLT performs unsigned multiplication on two 8-bit numbers yielding a 16-bit result. MLT may specify BC, DE, HL or SP registers. In all cases, the 8-bit

operands are loaded into each half of the 16-bit register and the 16-bit result is returned in that register.

**OTIM, OTIMR, OTDM, OTDMR - Block I/O.** The contents of memory pointed to by HL is output to the I/O address in (C). The memory address (HL) and I/O address (C) are incremented in OTIM and OTIMR and decremented in OTDM and OTDMR, respectively. The B register is decremented. The OTIMR and OTDMR variants repeat the above sequence until register B is decremented to 0. Since the I/O address (C) is automatically incremented or decremented, these instructions are useful for block I/O (such as Z80180 on-chip I/O) initialization. When I/O is accessed, 00H is output in high-order bits of address automatically.

**TSTIO m - Test I/O Port.** The contents of the I/O port addressed by C are ANDed with immediately specified 8-bit data and the status flags are updated. The I/O port contents are not written (non-destructive AND). When I/O is accessed, 00H is output in higher bits of address automatically.

**TST g - Test Register.** The contents of the specified register are ANDed with the accumulator (A) and the status flags are updated. The accumulator and specified register are not changed (non-destructive AND).

**TST m - Test Immediate.** The contents of the immediately specified 8-bit data are ANDed with the accumulator (A) and the status flags are updated. The accumulator is not changed (non-destructive AND).

**TST (HL) - Test Memory.** The contents of memory pointed to by HL are ANDed with the accumulator (A) and the status flags are updated. The memory contents and accumulator are not changed (non-destructive AND).

**INO g, (m) - Input, Immediate I/O address.** The contents of immediately specified 8-bit I/O address are input into the specified register. When I/O is accessed, 00H is output in high-order bits of the address automatically.

**OUT0 (m), g - Output, Immediate I/O address.** The contents of the specified register are output to the immediately specified 8-bit I/O address. When I/O is accessed, 00H is output in high-order bits of the address automatically.

## CPU Registers

The Z80180 CPU registers consist of Register Set GR, Register Set GR' and Special Registers.

The Register Set GR consists of 8-bit Accumulator (A), 8-bit Flag Register (F), and three General Purpose Registers (BC, DE, and HL) which may be treated as 16-bit registers (BC, DE, and HL) or as individual 8-bit registers (B, C, D, E, H, and L) depending on the instruction to be executed. The Register Set GR' is alternate register set of Register Set GR and also contains Accumulator (A'), Flag Register (F') and three General Purpose Registers (BC', DE', and HL'). While the alternate Register Set GR' contents are not directly accessible, the contents can be programmably exchanged at high speed with those of Register Set GR.

The Special Registers consist of 8-bit Interrupt Vector Register (I), 8-bit R Counter (R), two 16-bit Index Registers (IX and IY), 16-bit Stack Pointer (SP), and 16-bit Program Counter (PC).

Fig. 87 shows CPU registers configuration.

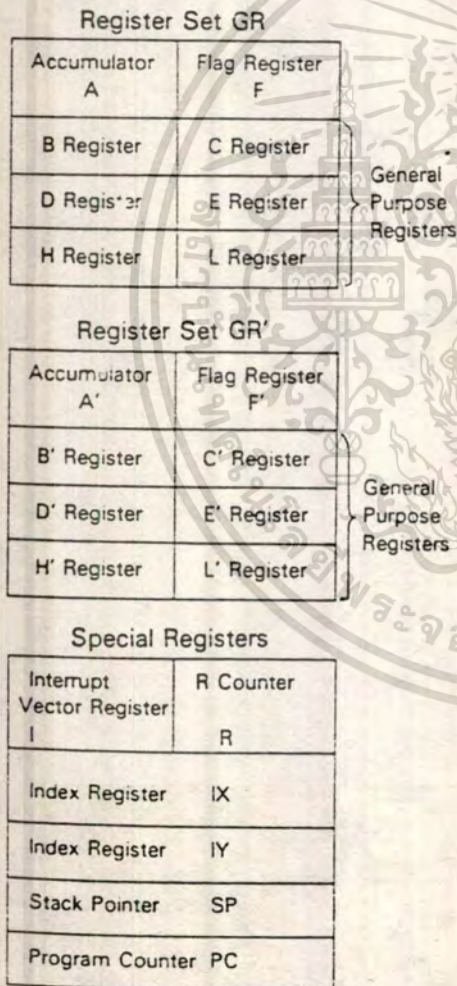

Figure 87. CPU Registers

### Accumulator (A, A')

The Accumulator (A) serves as the primary register used for many arithmetic, logical and I/O instructions.

### Flag Registers (F, F')

The flag register stores various status bits (described in the next section) which reflect the results of instruction execution.

### General Purpose Registers (BC, BC', DE, DE', HL, HL')

The General Purpose Registers are used for both address and data operation. Depending on instruction, each half (8 bits) of these registers (B, C, D, E, H, and L) may also be used.

### Interrupt Vector Register (I)

For interrupts which require a vector table address to be calculated ( $\overline{INT}_0$  Mode 2,  $\overline{INT}_1$ ,  $\overline{INT}_2$  and internal interrupts), the Interrupt Vector Register (I) provides the most significant byte of the vector table address. I is cleared to 00H during RESET.

### R Counter (R)

The least significant seven bits of the R counter (R) serve to count the number of instructions executed by the Z80180. R is incremented for each CPU op-code fetch cycle (each  $\overline{M}\overline{T}$  cycle). R is cleared to 00H during RESET.

### Index Registers (IX, and IY)

The Index Registers are used for both address and data operations. For addressing, the contents of a displacement specified in the instruction are added to or subtracted from the Index Register to determine an effective operand address.

### Stack Pointer (SP)

The Stack Pointer (SP) contains the memory address based LIFO stack. SP is cleared to 0000H during RESET.

### Program Counter (PC)

The Program Counter (PC) contains the address of the instruction to be executed and is automatically updated after each instruction fetch. PC is cleared to 0000H during RESET.

### Flag Register (F)

The Flag Register stores the logical state reflecting the results of instruction execution. The contents of the Flag Register are used to control program flow and instruction operation.

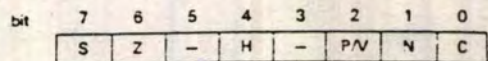

Figure 88. Flag Register (F)

### S: Sign (bit 7)

S stores the state of the most significant bit (bit 7) of the result. This is useful for operations with signed numbers in which values with bit 7 = 1 are interpreted as negative.

**Z: Zero (bit 6)**

Z is set to 1 when instruction execution produces 0 result. Otherwise, Z is reset to 0.

**H: Half Carry (bit 4)**

H is used by the DAA (Decimal Adjust Accumulator) instruction to reflect borrow or carry from the least significant 4 bits and thereby adjust the results of BCD addition and subtraction.

**P/V: Parity/Overflow (bit 2)**

P/V serves a dual purpose. For logical operations P/V is set to 1 if the number of 1 bit in the result is even and P/V is reset to 0 if the number of 1 in the result is odd. For two complement arithmetic, P/V is set to 1 if the operation produces a result which is outside the allowable range (+ 127 to - 128 for 8-bit operations, + 32767 to - 32768 for 16-bit operations).

**N: negative (bit 1)**

N is set to 1 if the last arithmetic instruction was a subtract operation (SUB, DEC, CP, etc.) and N is reset to 0 if the last arithmetic instruction was an addition operation (ADD, INC, etc.).

**C: Carry (bit 0)**

C is set to 1 when a carry (addition) or borrow (subtraction) from the most significant bit of the result occurs. C is also affected by Accumulator logic operations such as shifts and rotates.

**Addressing Modes**

The Z80180 instruction set includes eight addressing modes.

- Implied Register
- Register Direct
- Register Indirect
- Indexed
- Extended
- Immediate
- Relative
- IO

**Implied Register (IMP)**

Certain op-codes automatically imply register usage, such as the arithmetic operations which inherently reference the Accumulator, index Registers, Stack Pointer and General Purpose Registers.

**Register Direct (REG)**

Many op-codes contain bit fields specifying registers to be used for the operation. The exact bit field definitions vary depending on instruction as follows.

**8-bit Register**

g or g' field	Register
0 0 0	B
0 0 1	C
0 1 0	D
0 1 1	E
1 0 0	H
1 0 1	L
1 1 0	—
1 1 1	A

ww field	Register
0 0	B C
0 1	D E
1 0	H L
1 1	S P

xx field	Register
0 0	B C
0 1	D E
1 0	I X
1 1	S P

**16-bit Register**

zz field	Register
0 0	B C
0 1	D E
1 0	H L
1 1	A F

yy field	Register
0 0	B C
0 1	D E
1 0	I Y
1 1	S P

Suffixed H and L to ww,xx,yy,zz (ex. wwH,IXL) indicate upper and lower 8-bit of the 16-bit register respectively.

**Figure 89. Register Direct - Bit Field Definitions**

**Register Indirect (REG)**

The memory operand address is contained in one of the 16-bit General Purpose Registers (BC, DE, and HL).

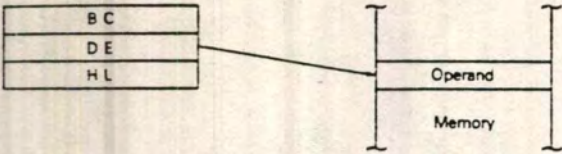

Figure 90. Register Indirect Addressing

**Indexed (INDX)**

The memory operand address is calculated using the contents of an Index Register (IX or IY) and an 8-bit signed displacement specified in the instruction.

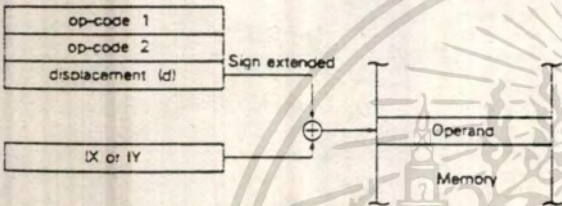

Figure 91. Indexed Addressing

**Extended (EXT)**

The memory operand address is specified by two bytes contained in the instruction.

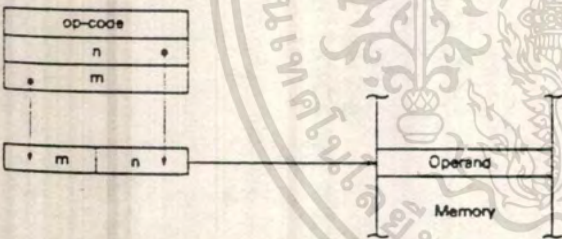

Figure 92. Extended Addressing

**Immediate (IMMED)**

The memory operands are contained within one or two bytes of the instruction.

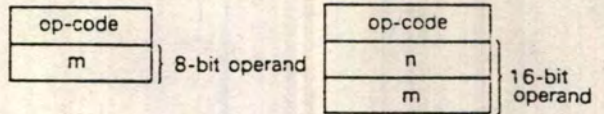

Figure 93. Immediate Addressing

**Relative (REL)**

Relative addressing mode is only used by the conditional and unconditional branch instructions. The branch displacement (relative to the contents of the program counter) is contained in the instruction.

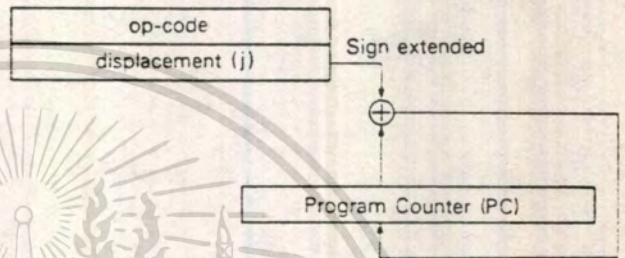

Figure 94. Relative Addressing

**IO (IO)**

IO addressing mode is used only by I/O instructions. This mode specifies I/O address (IORQ = 0) and outputs them as follows.

- (1) An operand is output to A<sub>0</sub>-A<sub>7</sub>. The Contents of Accumulator is output to A<sub>8</sub>-A<sub>15</sub>.
- (2) The Contents of Register B is output to A<sub>0</sub>-A<sub>7</sub>. The Contents of Register C is output to A<sub>8</sub>-A<sub>15</sub>.
- (3) An operand is output to A<sub>0</sub>-A<sub>7</sub>. 00H is output to A<sub>8</sub>-A<sub>15</sub>. (useful for internal I/O register access)
- (4) The Contents of Register C is output to A<sub>0</sub>-A<sub>7</sub>. 00H is output to A<sub>8</sub>-A<sub>15</sub>. (useful for internal I/O register access)

## Z80180 ELECTRICAL CHARACTERISTICS

### ABSOLUTE MAXIMUM RATINGS

Item	Symbol	Value	Unit
Supply Voltage	$V_{CC}$	-0.3 ~ +7.0	V
Input Voltage	$V_{in}$	-0.3 ~ $V_{CC}+0.3$	V
Operating Temperature	$T_{opr}$	0 ~ 70	°C
Storage Temperature	$T_{stg}$	-55 ~ +150	°C

[NOTE] Permanent LSI damage may occur if maximum ratings are exceeded. Normal operation should be under recommended operating conditions. If these conditions are exceeded, it could affect reliability of LSI.

### DC CHARACTERISTICS

( $V_{CC} = 5V \pm 10\%$ ,  $V_{SS} = 0V$ ,  $T_a = 0 \sim +70^\circ C$ , unless otherwise noted.)

Symbol	Item	Condition	min	typ	max	Unit
$V_{IH1}$	Input "H" Voltage RESET, EXTAL, NMI		$V_{CC}-0.6$	-	$V_{CC}+0.3$	V
$V_{IH2}$	Input "H" Voltage Except RESET, EXTAL, NMI		2.0	-	$V_{CC}+0.3$	V
$V_{IL1}$	Input "L" Voltage RESET, EXTAL, NMI		-0.3	-	0.6	V
$V_{IL2}$	Input "L" Voltage Except RESET, EXTAL, NMI		-0.3	-	0.8	V
$V_{OH}$	Output "H" Voltage All outputs	$I_{OH} = -200\mu A$	2.4	-	-	V
		$I_{OH} = -20\mu A$	$V_{CC}-1.2$	-	-	
$V_{OL}$	Output "L" Voltage All Outputs	$I_{OL} = 2.2 mA$	-	-	0.45	V
$I_L$	Input Leakage Current All Inputs Except XTAL, EXTAL	$V_{in} = 0.5 \sim V_{CC}-0.5$	-	-	1.0	$\mu A$
$I_{L3}$	Three State Leakage Current	$V_{in} = 0.5 \sim V_{CC}-0.5$	-	-	1.0	$\mu A$
$P_{CC}^*$	Power Dissipation* (Normal Operation)	$f = 6 MHz$	-	15	30	mA
		$f = 8 MHz$	-	20	40	
		$f = 10MHz$ **	-	25	50	
	Power Dissipation* (SYSTEM STOP mode)	$f = 6 MHz$	-	3.8	7.5	
		$f = 8 MHz$	-	5	10	
		$f = 10MHz$ **	-	6.3	12.5	
$C_p$	Pin Capacitance	$V_{in} = 0V, f = 1 MHz$ $T_a = 25^\circ C$	-	-	12	pF

\*  $V_{IHmin} = V_{CC}-1.0V$ ,  $V_{Lmax} = 0.8V$  (all output terminals are at no load.)

## Z80180 AC CHARACTERISTICS

( $V_{CC} = 5V \pm 10\%$ ,  $V_{SS} = 0V$ ,  $T_a = 0$  to  $+70^\circ C$ , unless otherwise noted.)

No.	Symbol	Item	Z80180-6		Z80180-8		Z80180-10 **		Unit	
			min	max	min	max	min	max		
1.	$t_{CYC}$	Clock Cycle Time	162	2000	125	2000	100	2000	ns	
2.	$t_{CHW}$	Clock "H" Pulse Width	65	—	50	—	40	—	ns	
3.	$t_{CLW}$	Clock "L" Pulse Width	65	—	50	—	40	—	ns	
4.	$t_{CF}$	Clock Fall Time	—	15	—	15	—	10	ns	
5.	$t_{CR}$	Clock Rise Time	—	15	—	15	—	10	ns	
6.	$t_{AD}$	$\emptyset \uparrow$ to Address Valid Delay	—	90	—	80	—	70	ns	
7.	$t_{AS}$	Address Valid to ( $\overline{MREQ} \uparrow$ or $\overline{IORQ} \downarrow$ )	30	—	20	—	10	—	ns	
8.	$t_{MED1}$	$\emptyset \downarrow$ to $\overline{MREQ} \downarrow$ Delay	—	60	—	50	—	50	ns	
9.	$t_{RDD1}$	$\emptyset \downarrow$ to $\overline{RD} \downarrow$ Delay	$\overline{IOCS} = 1$	—	60	—	50	—	50	ns
		$\emptyset \uparrow$ to $\overline{RD} \downarrow$ Delay	$\overline{IOCS} = 0$	—	65	—	60	—	55	
10.	$t_{M1D1}$	$\emptyset \uparrow$ to $\overline{M1} \downarrow$ Delay	—	80	—	70	—	60	ns	
11.	$t_{AH}$	Address Hold Time from ( $\overline{MREQ}$ , $\overline{IOREQ}$ , $\overline{RD}$ , $\overline{WR}$ )	35	—	20	—	10	—	ns	
12.	$t_{MED2}$	$\emptyset \downarrow$ to $\overline{MREQ} \uparrow$ Delay	—	60	—	50	—	50	ns	
13.	$t_{RDD2}$	$\emptyset \downarrow$ to $\overline{RD} \uparrow$ Delay	—	60	—	50	—	50	ns	
14.	$t_{M1D2}$	$\emptyset \uparrow$ to $\overline{M1} \uparrow$ Delay	—	80	—	70*	—	60	ns	
15.	$t_{DRS}$	Data Read Set-up Time	40	—	30	—	25	—	ns	
16.	$t_{DRH}$	Data Read Hold Time	0	—	0	—	0	—	ns	
17.	$t_{STD1}$	$\emptyset \downarrow$ to $\overline{ST} \downarrow$ Delay	—	90	—	70	—	60	ns	
18.	$t_{STD2}$	$\emptyset \downarrow$ to $\overline{ST} \uparrow$ Delay	—	90	—	70	—	60	ns	
19.	$t_{WS}$	WAIT Set-up Time to $\emptyset \downarrow$	40	—	40	—	30	—	ns	
20.	$t_{WH}$	WAIT Hold Time from $\emptyset \downarrow$	40	—	40	—	30	—	ns	
21.	$t_{WDZ}$	$\emptyset \uparrow$ to Data Float Display	—	95	—	70	—	60	ns	
22.	$t_{WRD1}$	$\emptyset \uparrow$ to $\overline{WR} \downarrow$ Delay	—	65	—	60	—	50	ns	
23.	$t_{WDD}$	$\emptyset \downarrow$ to Write Data Delay Time	—	90	—	80	—	60	ns	
24.	$t_{WDS}$	Write Data Set-up Time to $\overline{WR} \downarrow$	40	—	20	—	15	—	ns	
25.	$t_{WRD2}$	$\emptyset \downarrow$ to $\overline{WR} \uparrow$ Delay	—	80	—	60	—	50	ns	
26.	$t_{WRP}$	WR Pulse Width	170	—	130	—	110	—	ns	

Symbol	Item	Z80180-6		Z80180-8		Z80180-10 **		Unit
		min	max	min	max	min	max	
27. t <sub>WDH</sub>	Write Data Hold Time from (WR ↑)	40	—	15	—	10	—	ns
t <sub>001</sub>	∅ ↓ to IORQ ↓ Delay	I/O = 1	—	60	—	50	—	ns
		I/O = 0	—	65	—	60	—	
29. t <sub>002</sub>	∅ ↓ to IORQ ↑ Delay	—	60	—	50	—	50	ns
30. t <sub>003</sub>	Mi ↓ to IORQ ↓ Delay	340	—	250	—	200	—	ns
31. t <sub>INTS</sub> <sup>c</sup>	INT Set-up Time to ∅ ↓	40	—	40	—	30	—	ns
32. t <sub>INTH</sub>	INT Hold Time from ∅ ↓	40	—	40	—	30	—	ns
33. t <sub>NMW</sub>	NMI Pulse Width	120	—	100	—	80	—	ns
34. t <sub>BRS</sub>	BUSREQ Set-up Time to ∅ ↓	40	—	40	—	30	—	ns
35. t <sub>BRH</sub>	BUSREQ Hold Time from ∅ ↓	40	—	40	—	30	—	ns
36. t <sub>BAD1</sub>	∅ ↑ to BUSACK ↓ Delay	—	95	—	70	—	60	ns
37. t <sub>BAD2</sub>	∅ ↓ to BUSACK ↑ Delay	—	95	—	70	—	60	ns
38. t <sub>BZD</sub>	∅ ↑ to Bus Floating Delay Time	—	125	—	90	—	80	ns
39. t <sub>MEWH</sub>	MREQ Pulse Width (HIGH)	110	—	90	—	70	—	ns
40. t <sub>MEWL</sub>	MREQ Pulse Width (LOW)	125	—	100	—	80	—	ns
41. t <sub>RFD1</sub>	∅ ↑ to RFSH ↓ Delay	—	90	—	80	—	60	ns
42. t <sub>RFD2</sub>	∅ ↑ to RFSH ↑ Delay	—	90	—	80	—	60	ns
43. t <sub>HAD1</sub>	∅ ↑ to HALT ↓ Delay	—	90	—	80	—	50	ns
44. t <sub>HAD2</sub>	∅ ↑ to HALT ↑ Delay	—	90	—	80	—	50	ns
45. t <sub>ORCS</sub>	DREQi Set-up Time to ∅ ↑	40	—	40	—	30	—	ns
46. t <sub>ORCH</sub>	DREQi Hold Time from ∅ ↑	40	—	40	—	30	—	ns
47. t <sub>TED1</sub>	∅ ↓ to TENDi ↓ Delay	—	70	—	60	—	50	ns
48. t <sub>TED2</sub>	∅ ↓ to TENDi ↑ Delay	—	70	—	60	—	50	ns
49. t <sub>ED1</sub>	∅ ↑ to E ↑ Delay	—	95	—	70	—	60	ns
50. t <sub>ED2</sub>	∅ ↓ or ↑ to E ↓ Delay	—	95	—	70	—	60	ns
51. P <sub>WEH</sub>	E Pulse Width (HIGH)	75	—	65	—	55	—	ns
52. P <sub>WEL</sub>	E Pulse Width (LOW)	180	—	130	—	110	—	ns

Symbol	Item	Z80180-6		Z80180-8		Z80180-10 **		Unit
		min	max	min	max	min	max	
53.	$t_{er}$ Enable Rise Time	—	20	—	20	—	20	ns
54.	$t_{ef}$ Enable Fall Time	—	20	—	20	—	20	ns
55.	$t_{TOD}$ $\emptyset \downarrow$ to Timer Output Delay	—	300	—	200	—	150	ns
56.	$t_{STD1}$ CSI/O Transmit Data Delay Time (Internal Clock Operation)	—	200	—	200	—	150	ns
57.	$t_{STDE}$ CSI/O Transmit Data Delay Time (External Clock Operation)	—	7.5tcyc + 300	—	7.5tcyc + 200	—	7.5tcyc + 150	ns
58.	$t_{SRSI}$ CSI/O Receive Data Set-up Time (Internal Clock Operation)	1	—	1	—	1	—	tcyc
59.	$t_{SRH}$ CSI/O Receive Data Hold Time (Internal Clock Operation)	1	—	1	—	1	—	tcyc
60.	$t_{SRSE}$ CSI/O Receive Data Set-up Time (External Clock Operation)	1	—	1	—	1	—	tcyc
61.	$t_{SRHE}$ CSI/O Receive Data Hold Time (External Clock Operation)	1	—	1	—	1	—	tcyc
62.	$t_{RES}$ $\overline{RESET}$ Set-up Time to $\emptyset \downarrow$	120	—	100	—	80	—	ns
63.	$t_{REH}$ $\overline{RESET}$ Hold Time from $\emptyset \downarrow$	80	—	70	—	50	—	ns
64.	$t_{OSC}$ Oscillator Stabilization Time	—	20	—	20	—	TBD	ms
65.	$t_{EXr}$ External Clock Rise Time (EXTAL)	—	25	—	25	—	25	ns
66.	$t_{EXf}$ External Clock Fall Time (EXTAL)	—	25	—	25	—	25	ns
67.	$t_{Rr}$ $\overline{RESET}$ Rise Time	—	50	—	50	—	50	ms
68.	$t_{Rf}$ $\overline{RESET}$ Fall Time	—	50	—	50	—	50	ms
69.	$t_r$ Input Rise Time (except EXTAL $\overline{RESET}$ )	—	100	—	100	—	100	ns
70.	$t_f$ Input Fall Time (except EXTAL $\overline{RESET}$ )	—	100	—	100	—	100	ns

\*\* Vcc = 5v  $\pm$  5%

TIMING DIAGRAMS

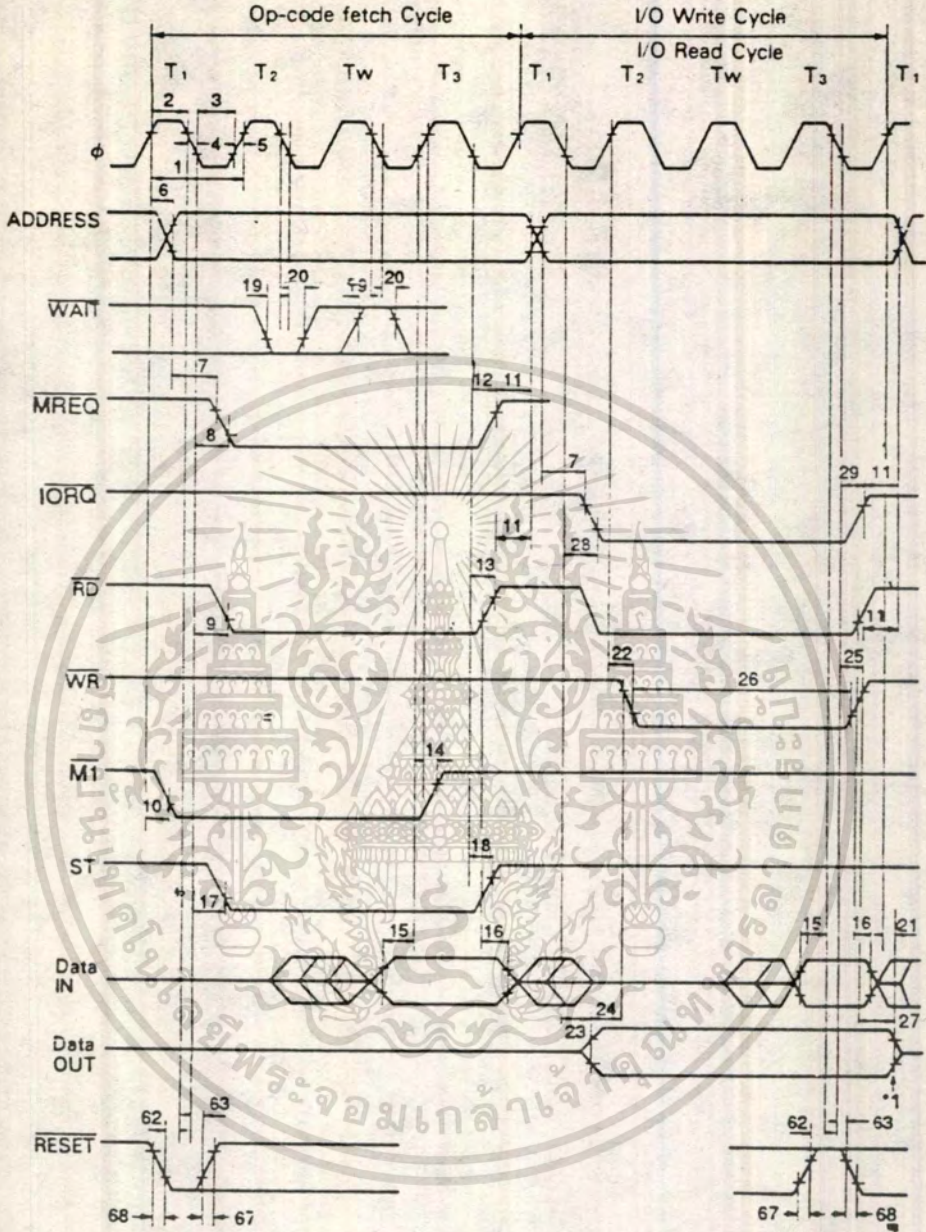

\*1 Output buffer is off at this point.

CPU Timing ( Op-code fetch Cycle  
I/O Write Cycle  
I/O Read Cycle )

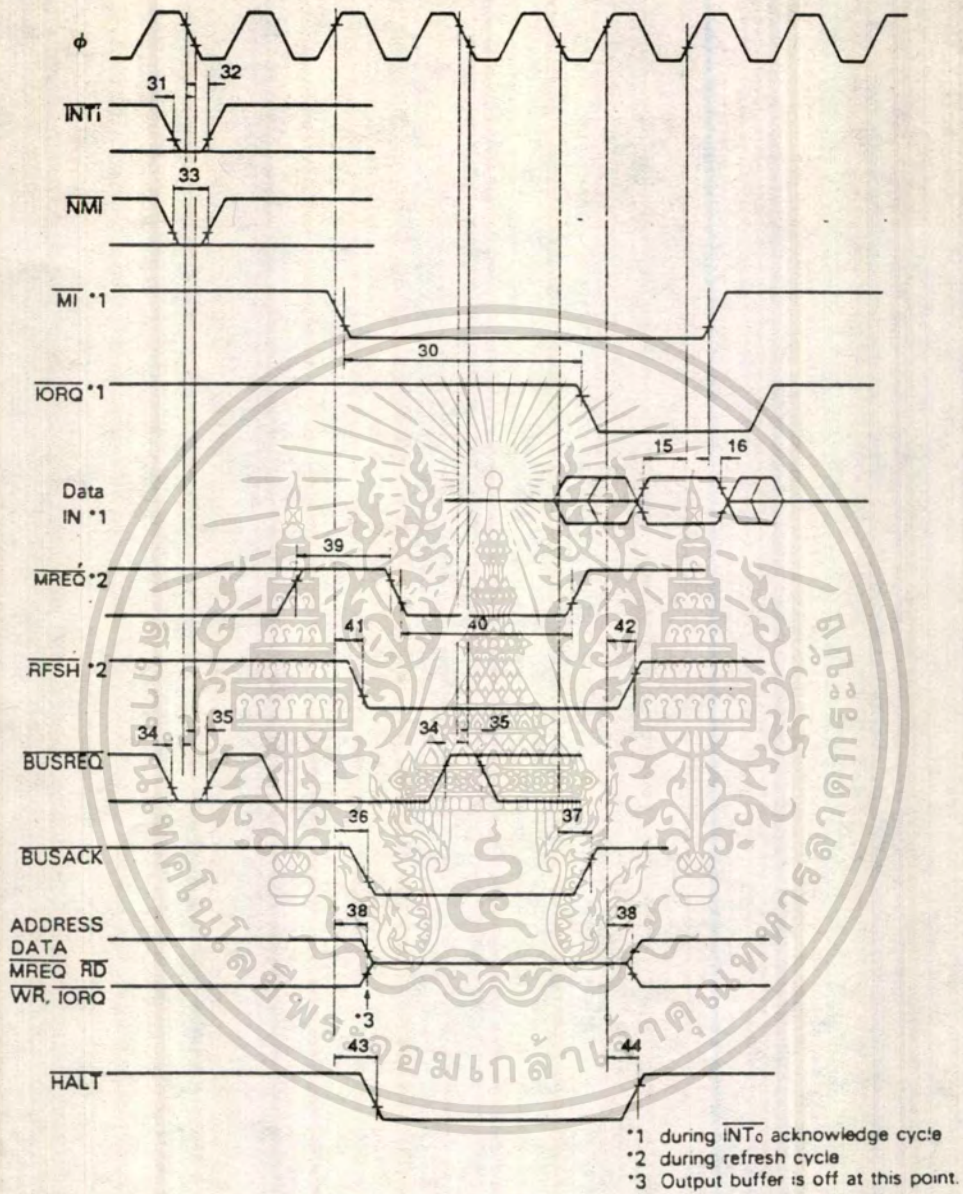

CPU Timing (  $\overline{\text{INT}}_0$  Acknowledge cycle  
 Refresh Cycle  
 BUS RELEASE Mode  
 HALT Mode  
 SLEEP Mode  
 SYSTEM STOP Mode )

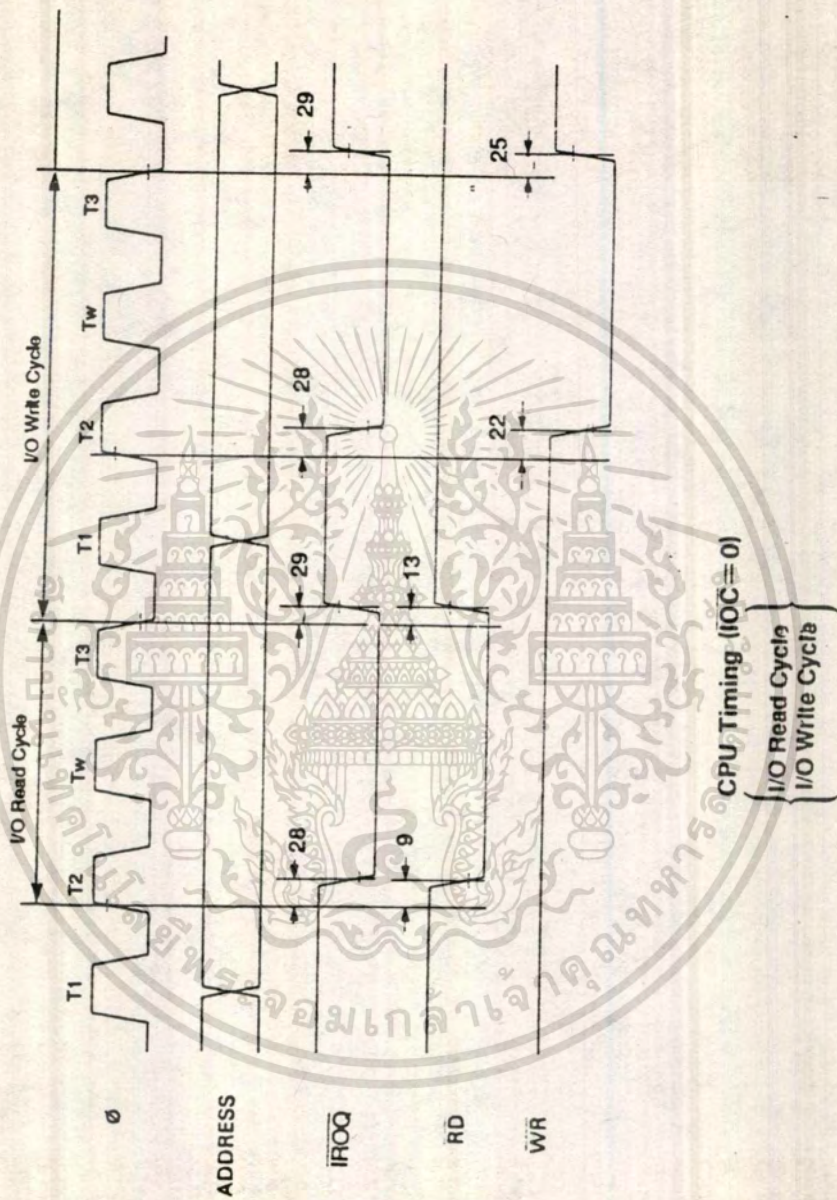

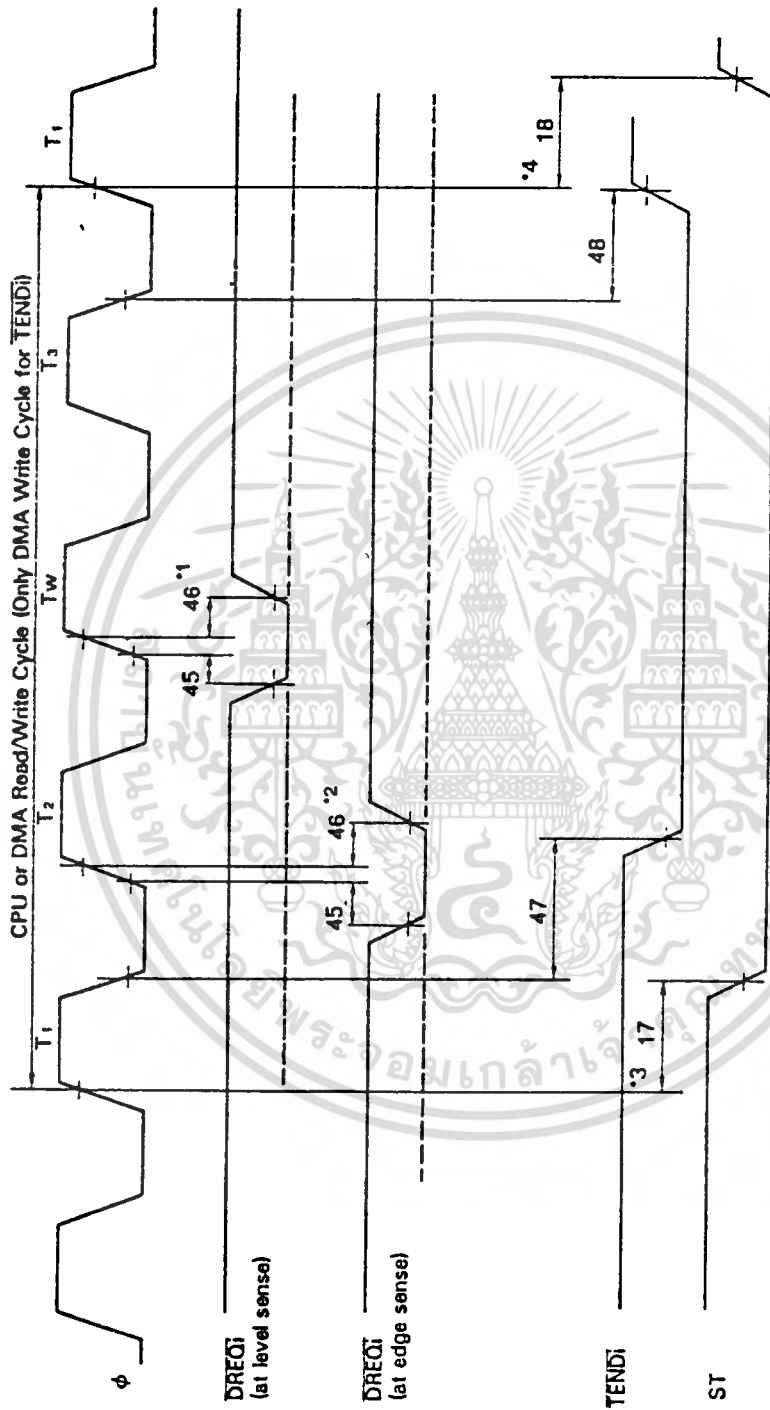

#### DMA Control Signals

- \*1  $t_{DREQ}$  and  $t_{DREQI}$  are specified for the rising edge of clock followed by  $T_3$ .
- \*2  $t_{DREQ}$  and  $t_{DREQI}$  are specified for the rising edge of clock.
- \*3 DMA cycle starts.
- \*4 CPU cycle starts.

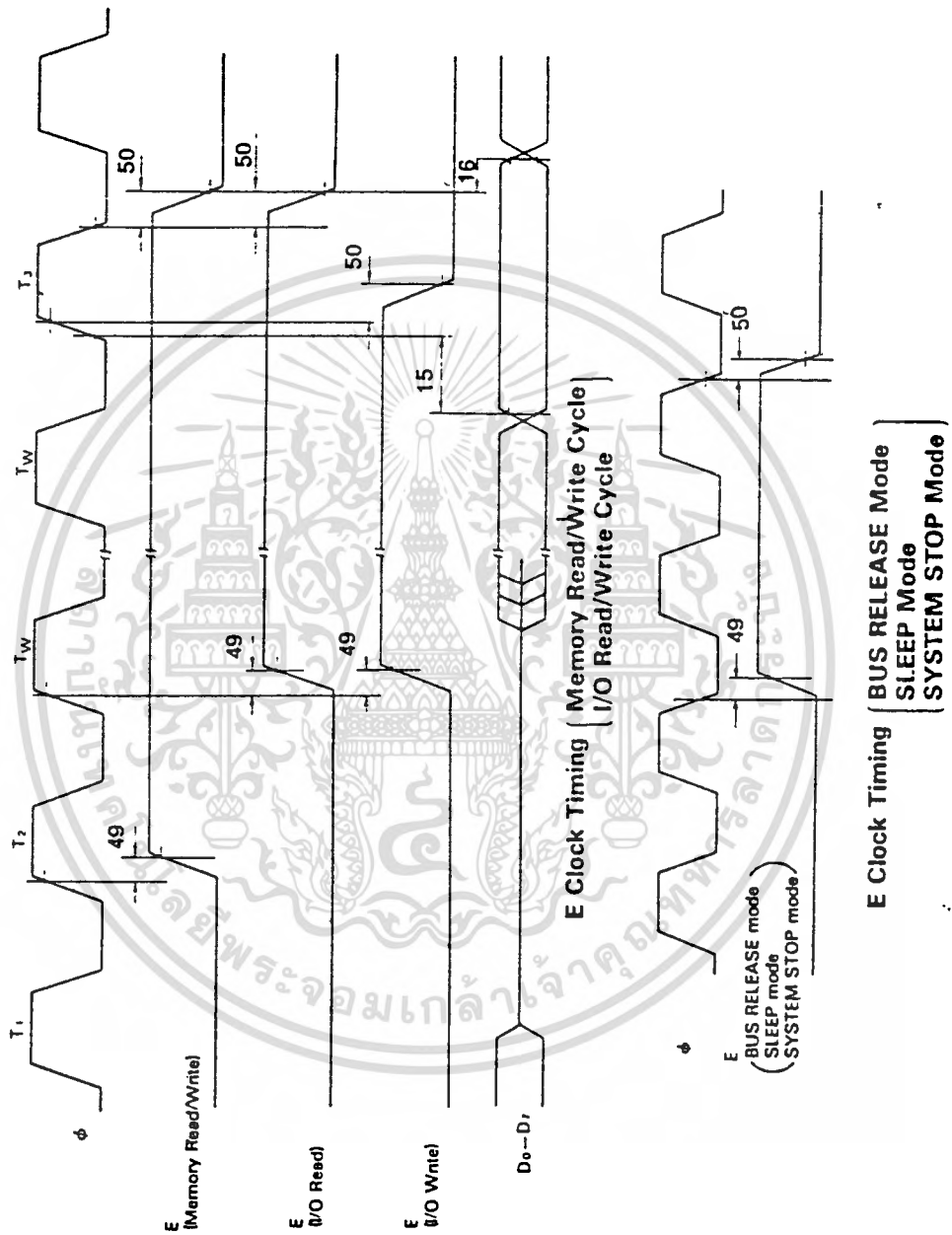

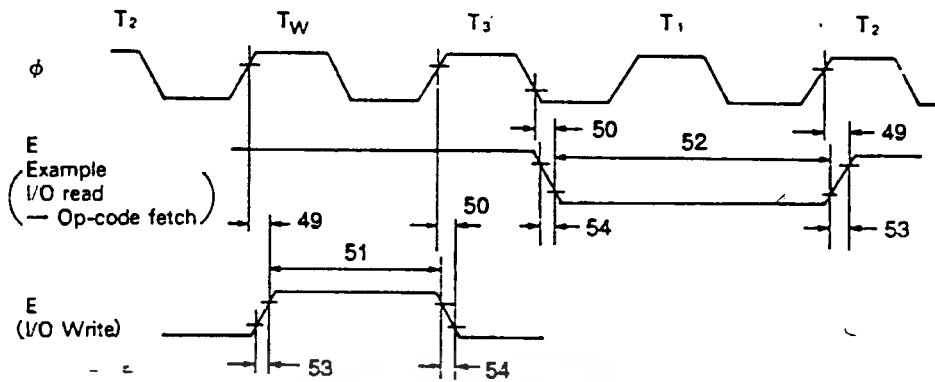

E Clock Timing (Minimum timing example of  $P_{WEL}$  and  $P_{WEH}$ )

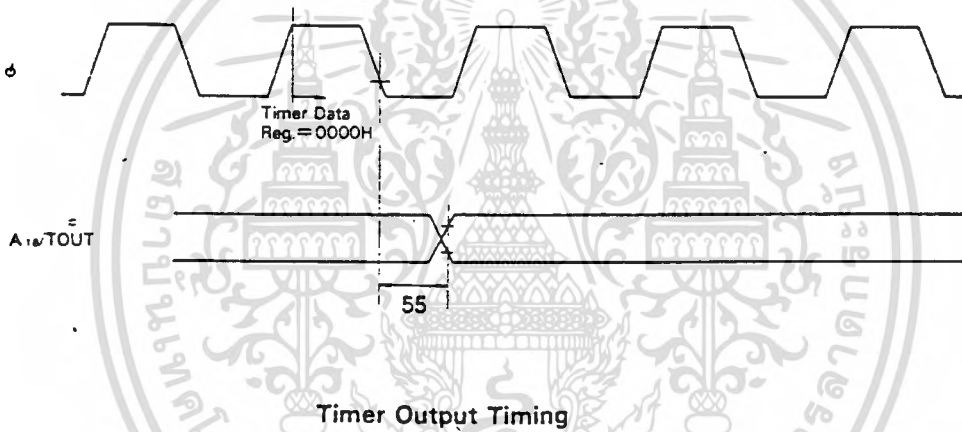

Timer Output Timing

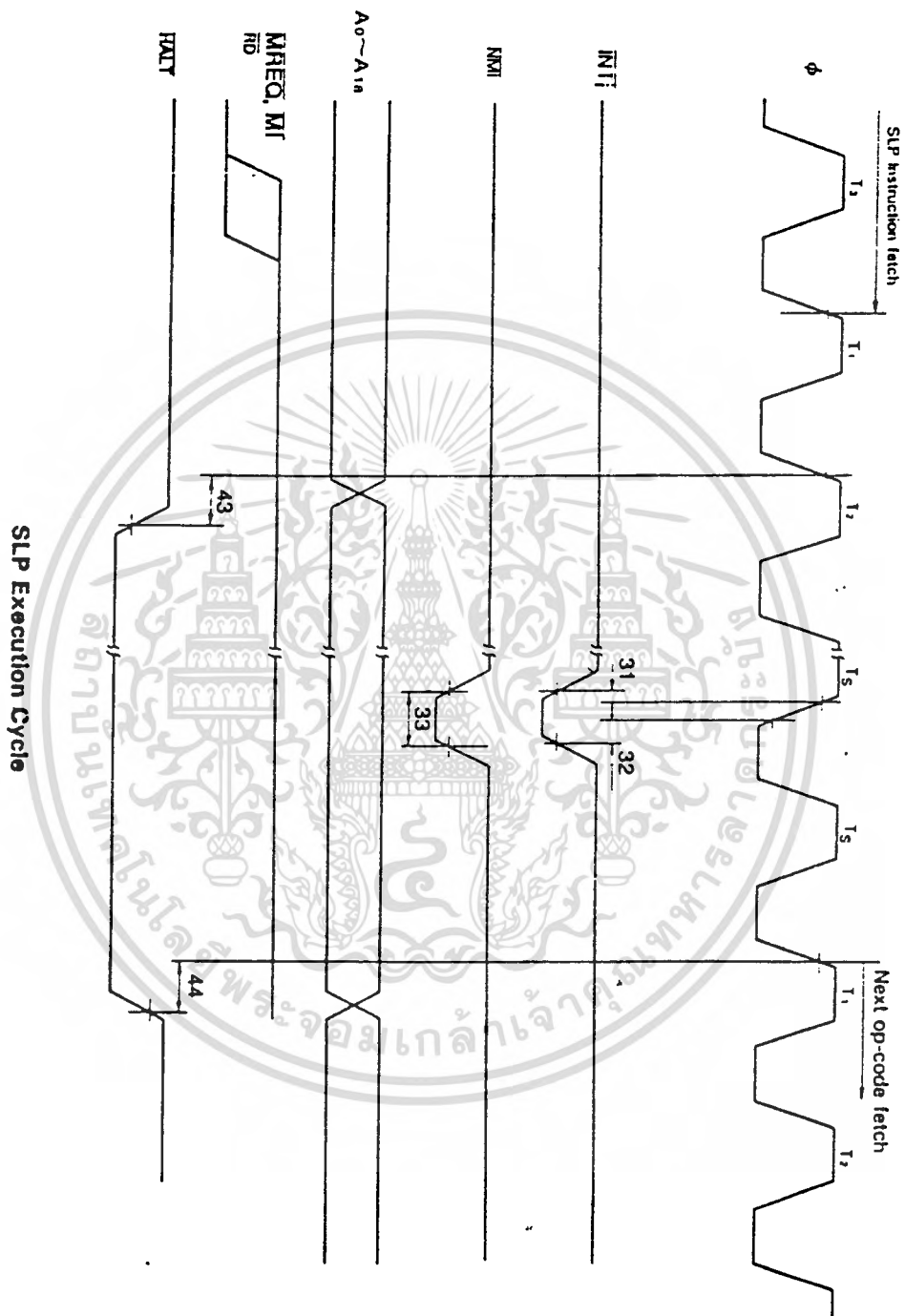

SLP Execution Cycle

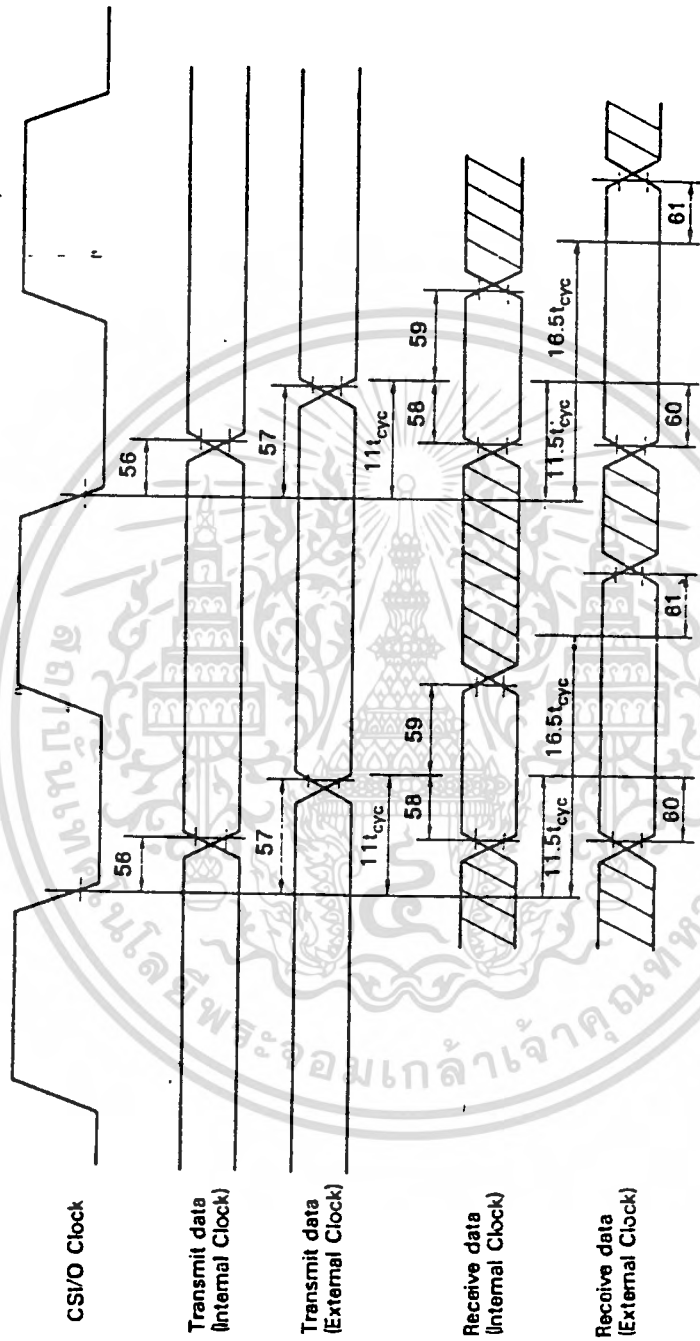

CSI/O Receive/Transmit Timing

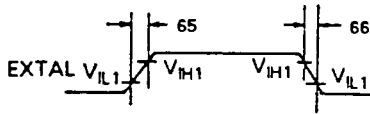

External Clock Rise Time and Fall Time

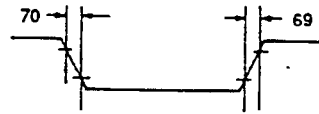

Input Rise Time and Fall Time  
(Except EXTAL, RESET)

### STANDARD TEST CONDITIONS:

The DC Characteristics and Capacitance sections above apply to the following standard test conditions, unless otherwise noted. All voltages are referenced to GND (0V). Positive current flows in to the referenced pin.

The Ordering Information section lists temperature ranges and product numbers. Package drawings are in the Package Information section. Refer to the Literature List for additional documentation.

All AC parameters assume a load capacitance of 100 pF. Add 10 ns delay for each 50 pF increase in load up to a maximum of 200 pF for the data bus and 100 pF for the address and control lines. AC timing measurements are referenced to 1.5 volts (except for CLOCK, which is referenced to the 10% and 90% points).

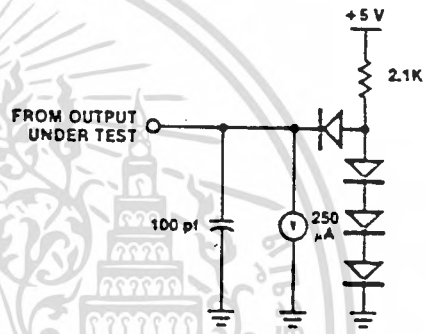

# APPENDICES

## A. Instruction Set

The following explains the symbols in instruction set.

### 1. Register

g, g', ww, xx, yy, and zz specify a register to be used. g and g' specify an 8-bit register. ww, xx, yy, and zz specify a pair of 16-bit registers. The following tables show the correspondence between symbols and registers.

g, g'	Reg.	ww	Reg.	xx	Reg.	yy	Reg.	zz	Reg.
000	B	00	BC	00	BC	00	BC	00	BC
001	C	01	DE	01	DE	01	DE	01	DE
010	D	10	HL	10	IX	10	IY	10	HL
011	E	11	SP	11	SP	11	SP	11	AF
100	H								
101	L								
111	A								

NOTE: Suffixed H and L to ww, xx, yy, zz (ex. wwH, IXL) indicate upper and lower 8-bit of the 16-bit register respectively.

### 2. Bit

b specifies a bit to be manipulated in the bit manipulation instruction. The following table shows the correspondence between b and bits.

b	Bit
000	0
001	1
010	2
011	3
100	4
101	5
110	6
111	7

### 3. Condition

f specifies the condition in program control instructions. The following shows the correspondence between f and conditions.

f	Condition
000	NZ non zero
001	Z zero
010	NC non carry
011	C carry
100	PO parity odd
101	PE parity even
110	P sign plus
111	M sign minus

### 4. Restart Address

v specifies a restart address. The following table shows the correspondence between v and restart addresses.

v	Address
000	00H
001	08H
010	10H
011	18H
100	20H
101	28H
110	30H
111	38H

### 5. Flag

The following symbols show the flag conditions.

.	: not affected
↑	: affected
x	: undefined
S	: set to 1
R	: reset to 0
P	: parity
V	: overflow

### 6. Miscellaneous

( )M	: data in the memory address
( )I	: data in the I/O address
m or n	: 8-bit data
mn	: 16-bit data
r	: 8-bit register
R	: 16-bit register
b.( )M	: a content of bit b in the memory address
b.gr	: a content of bit b in the register gr
d or j	: 8-bit signed displacement
S	: source addressing
D	: destination addressing mode
.	: AND operation.
+	: OR operation
⊕	: EXCLUSIVE OR operation
**	: added new instructions to Z80

## 1. Data Manipulation Instructions

### (1) Arithmetic and Logical Instructions (8-bit)

Operation name	MNEMONICS	OP code	Addressing							Bytes	Status	Operation	Flag							
			IMM	EXT	IND	REG	REGH	D/P	REL				S	Z	H	P/V	N	C		
ADD	ADD R	10 000 0				S			D	1	4	$Ar+R-Ar$	1	1	1	1	V	R	1	
	ADD A:(HL)	10 000 110					S		D	1	6	$Ar+(HL)_0-Ar$	1	1	1	1	V	R	1	
	ADD Am	11 000 110 ( m )	S						D	2	6	$Ar+m-Ar$	1	1	1	1	V	R	1	
	ADD A:(IX+d)	11 011 101 10 000 110 ( d )			S				D	3	14	$Ar+(IX+d)_0-Ar$	1	1	1	1	V	R	1	
	ADD A:(IY+d)	11 111 101 10 000 110 ( d )			S				D	3	14	$Ar+(IY+d)_0-Ar$	1	1	1	1	V	R	1	
	ADC	ADC R	10 001 0				S			D	1	4	$Ar+R+c-Ar$	1	1	1	1	V	R	1
ADC A:(HL)	10 001 110					S			D	1	6	$Ar+(HL)_0+c-Ar$	1	1	1	1	V	R	1	
ADC Am	11 001 110 ( m )	S							D	2	6	$Ar+m+c-Ar$	1	1	1	1	V	R	1	
ADC A:(IX+d)	11 011 101 10 001 110 ( d )			S					D	3	14	$Ar+(IX+d)_0+c-Ar$	1	1	1	1	V	R	1	
ADC A:(IY+d)	11 111 101 10 001 110 ( d )			S					D	3	14	$Ar+(IY+d)_0+c-Ar$	1	1	1	1	V	R	1	
AND	AND R	10 100 0				S			D	1	4	$Ar\&R-Ar$	1	1	S	P	R	R		
	AND A:(HL)	10 100 110					S		D	1	6	$Ar\&(HL)_0-Ar$	1	1	S	P	R	R		
	AND m	11 100 110 ( m )	S						D	2	6	$Ar\&m-Ar$	1	1	S	P	R	R		
	AND A:(IX+d)	11 011 101 10 100 110 ( d )			S				D	3	14	$Ar\&(IX+d)_0-Ar$	1	1	S	P	R	R		
	AND A:(IY+d)	11 111 101 10 100 110 ( d )			S				D	3	14	$Ar\&(IY+d)_0-Ar$	1	1	S	P	R	R		
	Compare	CP R	10 111 0				S			D	1	4	$Ar-R$	1	1	1	1	V	S	1
CP A:(HL)		10 111 110					S		D	1	6	$Ar-(HL)_0$	1	1	1	1	V	S	1	
CP m		11 111 110 ( m )	S						D	2	6	$Ar-m$	1	1	1	1	V	S	1	
CP A:(IX+d)		11 011 101 10 111 110 ( d )			S				D	3	14	$Ar-(IX+d)_0$	1	1	1	1	V	S	1	
CP A:(IY+d)		11 111 101 10 111 110 ( d )			S				D	3	14	$Ar-(IY+d)_0$	1	1	1	1	V	S	1	
COMPLEMENT		CPL	00 101 111							S/D	1	3	$\bar{Ar}-Ar$	-	-	S	-	S	-	
DEC	DEC R	00 110 101					S/D		S/D	1	4	$R-1-R$	1	1	1	1	V	S	-	
	DEC A:(HL)	00 110 110					S/D		S/D	1	6	$(HL)_0-1-(HL)_0$	1	1	1	1	V	S	-	
	DEC A:(IX+d)	11 011 101 00 110 101 ( d )			S/D				S/D	3	18	$(IX+d)_0-1-(IX+d)_0$	1	1	1	1	V	S	-	
	DEC A:(IY+d)	11 111 101 00 110 101 ( d )			S/D				S/D	3	18	$(IY+d)_0-1-(IY+d)_0$	1	1	1	1	V	S	-	
	INC	INC R	00 110 100					S/D		S/D	1	4	$R+1-R$	1	1	1	1	V	R	-
INC A:(HL)		00 110 110					S/D		S/D	1	6	$(HL)_0+1-(HL)_0$	1	1	1	1	V	R	-	
INC A:(IX+d)		11 011 101 00 110 100 ( d )			S/D				S/D	3	18	$(IX+d)_0+1-(IX+d)_0$	1	1	1	1	V	R	-	
INC A:(IY+d)		11 111 101 00 110 100 ( d )			S/D				S/D	3	18	$(IY+d)_0+1-(IY+d)_0$	1	1	1	1	V	R	-	

(to be continued)

Operation name	MNEMONICS	OP code	Addressing						Bytes	Status	Operation	Flag										
			IMMED	EXT	IND	REG	REGI	IMP				REL	7	6	4	2	1	0				
MULT	MLT $rr$ $rr$	11 101 100 01 100 100					S/D		2	17	$Ar \times Bc \rightarrow Ar$											
NEGATE	NEG	11 101 101 01 000 100					S/D		2	6	$B - Ar \rightarrow Ar$	1	1	1	V	S	1					
OR	OR $g$	10 110 $g$					S	D	1	4	$Ar \oplus Bg \rightarrow Ar$	1	1	R	P	R	2					
	OR (HL)	10 110 110					S	D	1	6	$Ar \oplus (HL)_a \rightarrow Ar$	1	1	R	P	R	R					
	OR $m$	11 110 110 ( $m$ )	S				D	D	2	6	$Ar \oplus m \rightarrow Ar$	1	1	R	P	R	R					
	OR (IX+d)	11 011 101 10 110 110 ( $d$ )			S			D	3	16	$Ar \oplus (IX+d)_a \rightarrow Ar$	1	1	R	P	R	R					
	OR (IY+d)	11 111 101 10 110 110 ( $d$ )			S			D	3	16	$Ar \oplus (IY+d)_a \rightarrow Ar$	1	1	R	P	R	R					
	SUB	SUB $g$	10 010 $g$					S	D	1	4	$Ar - Bg \rightarrow Ar$	1	1	I	V	S	1				
SUB (HL)		10 010 110					S	D	1	6	$Ar - (HL)_a \rightarrow Ar$	1	1	I	V	S	1					
SUB $m$		11 010 110 ( $m$ )	S				D	D	2	6	$Ar - m \rightarrow Ar$	1	1	I	V	S	1					
SUB (IX+d)		11 011 101 10 010 110 ( $d$ )			S			D	3	16	$Ar - (IX+d)_a \rightarrow Ar$	1	1	I	V	S	1					
SUB (IY+d)		11 111 101 10 010 110 ( $d$ )			S			D	3	16	$Ar - (IY+d)_a \rightarrow Ar$	1	1	I	V	S	1					
SBC		SBC $A, g$	10 011 $g$					S	D	1	4	$Ar - Bg - c \rightarrow Ar$	1	1	I	V	S	1				
	SBC A, (HL)	10 011 110					S	D	1	6	$Ar - (HL)_a - c \rightarrow Ar$	1	1	I	V	S	1					
	SBC $A, m$	11 011 110 ( $m$ )	S				D	D	2	6	$Ar - m - c \rightarrow Ar$	1	1	I	V	S	1					
	SBC A, (IX+d)	11 011 101 10 011 110 ( $d$ )			S			D	3	16	$Ar - (IX+d)_a - c \rightarrow Ar$	1	1	I	V	S	1					
	SBC A, (IY+d)	11 111 101 10 011 110 ( $d$ )			S			D	3	16	$Ar - (IY+d)_a - c \rightarrow Ar$	1	1	I	V	S	1					
	TEST	TST $g$ $rr$	11 101 101 00 $g$ 100					S	D	2	7	$Ar \wedge Bg$	1	1	S	P	R	R				
TST (HL) $rr$		11 101 101 00 110 100					S	D	2	10	$Ar \wedge (HL)_a$	1	1	S	P	R	R					
TST $m$ $rr$		11 101 101 01 100 100 ( $m$ )	S				D	D	3	9	$Ar \wedge m$	1	1	S	P	R	R					
XOR		XOR $g$	10 101 $g$					S	D	1	4	$Ar \oplus Bg \rightarrow Ar$	1	1	R	P	R	R				
	XOR (HL)	10 101 110					S	D	1	6	$Ar \oplus (HL)_a \rightarrow Ar$	1	1	R	P	R	R					
	XOR $m$	11 101 110 ( $m$ )	S				D	D	2	6	$Ar \oplus m \rightarrow Ar$	1	1	R	P	R	R					
	XOR (IX+d)	11 011 101 10 101 110 ( $d$ )			S			D	3	16	$Ar \oplus (IX+d)_a \rightarrow Ar$	1	1	R	P	R	R					
	XOR (IY+d)	11 111 101 10 101 110 ( $d$ )			S			D	3	16	$Ar \oplus (IY+d)_a \rightarrow Ar$	1	1	R	P	R	R					

(2) Rotate and Shift Instructions

Operation name	MNEMONICS	OP code	Addressing					Bytes	Status	Operation	Flag											
			IMMED	EXT	IND	REG	REG / IMP				REL	7	6	4	2	1	0					
Rotate and Shift Data	RLA	00 010 111						S/D		1	3		.	.	.	.	R	.	.	R	.	.
	RL g	11 001 011 00 010 g						S/D		2	7		.	.	.	.	R	.	.	R	.	.
RL (HL)	RL (HL)	11 001 011 00 010 110						S/D		2	12		.	.	.	.	R	.	.	R	.	.
	RL (IX+d)	11 001 101 00 010 110 < d >						S/D		4	19		.	.	.	.	R	.	.	R	.	.
RL (IY+d)	RL (IY+d)	00 010 110 11 001 011 < d >						S/D		4	19		.	.	.	.	R	.	.	R	.	.
	RLCA	00 010 110						S/D		1	3		.	.	.	.	R	.	.	R	.	.
RLC g	RLC g	11 001 011 00 000 g						S/D		2	7		.	.	.	.	R	.	.	R	.	.
	RLC (HL)	11 001 011 00 000 110						S/D		2	12		.	.	.	.	R	.	.	R	.	.
RLC (IX+d)	RLC (IX+d)	11 001 101 11 001 011 < d >						S/D		4	19		.	.	.	.	R	.	.	R	.	.
	RLC (IY+d)	00 000 110 11 001 011 < d >						S/D		4	19		.	.	.	.	R	.	.	R	.	.
RLD	RLD	00 000 110 11 101 101						S/D		2	16		.	.	.	.	R	.	.	R	.	.
	RRA	00 011 111						S/D		1	3		.	.	.	.	R	.	.	R	.	.
RR g	RR g	11 001 011 00 011 g						S/D		2	7		.	.	.	.	R	.	.	R	.	.
	RR (HL)	11 001 011 00 011 110						S/D		2	12		.	.	.	.	R	.	.	R	.	.
RR (IX+d)	RR (IX+d)	11 001 101 11 001 011 < d >						S/D		4	19		.	.	.	.	R	.	.	R	.	.
	RR (IY+d)	00 011 110 11 111 101 11 001 011 < d >						S/D		4	19		.	.	.	.	R	.	.	R	.	.
RRCa	RRCa	00 001 111 11 001 011						S/D		1	3		.	.	.	.	R	.	.	R	.	.
	RRC g	00 001 g						S/D		2	7		.	.	.	.	R	.	.	R	.	.
RRC (HL)	RRC (HL)	11 001 011 00 001 110						S/D		2	12		.	.	.	.	R	.	.	R	.	.
	RRC (IX+d)	11 011 101 11 001 011 < d >						S/D		4	19		.	.	.	.	R	.	.	R	.	.
RRC (IY+d)	RRC (IY+d)	00 001 110 11 111 101 11 001 011 < d >						S/D		4	19		.	.	.	.	R	.	.	R	.	.

(to be continued)



(4) Arithmetic Instructions (16-bit)

Operation name	MNEMONICS	OP code	Addressing						Byes	Status	Operation	Flag						
			IMM	EXT	IND	REG	REG2	DMP				REL	S	Z	H	P/V	N	C
ADD	ADD HL,ww	00 ww 1 001				S		D	1	7	$HL_0 + ww_0 - HL_0$	.	.	X	.	R	1	
	ADD HL,xx	11 011 101				S		D	2	10	$HL_0 + xx_0 - HL_0$	.	.	X	.	R	1	
	ADD rY,yy	00 xx 1 001				S							.	.	X	.	R	1
		00 yy 1 001				S								.	.	X	.	R
ADC	ADC HL,ww	11 101 101 01 ww 1 010				S		D	2	10	$HL_0 + ww_0 + c - HL_0$	1	1	X	V	R	1	
DEC	DEC ww	00 ww 1 011				S/D			1	4	$ww_0 - 1 - ww_0$	.	.	.	.	.	.	
	DEC IX	11 011 101				S/D		S/D	2	7	$IX_0 - 1 - IX_0$	.	.	.	.	.	.	
	DEC rY	00 101 011				S/D							.	.	.	.	.	
		00 111 101				S/D								.	.	.	.	
INC	INC ww	00 ww 0 011				S/D			1	4	$ww_0 + 1 - ww_0$	.	.	.	.	.	.	
	INC IX	11 011 101				S/D		S/D	2	7	$IX_0 + 1 - IX_0$	.	.	.	.	.	.	
	INC rY	00 100 011				S/D							.	.	.	.	.	
		00 111 101				S/D								.	.	.	.	
SBC	SBC HL,ww	11 101 101 01 ww 0 110				S		D	2	10	$HL_0 - ww_0 - c - HL_0$	1	1	X	V	S	1	



เอกสารนี้เป็นเอกสารที่สงวนไว้สำหรับการใช้งานเพื่อ 167 ศึกษาเท่านั้น ไม่อนุญาตให้นำไปใช้ประโยชน์ด้านการค้า  
ไม่ว่ากรณีใดๆทั้งสิ้น อีกทั้งห้ามมิให้ดัดแปลงเนื้อหา และต้องอ้างอิงถึงเจ้าของเอกสารทุกครั้งที่มีการนำไปใช้

## 2. Data Transfer Instructions

### (1) 8-Bit Load

Operation name	MNEMONICS	OP code	Addressing						Bytes	Status	Operation	Flag								
			IMM	EXT	IND	REG	REGI	IMP				REL	7	6	4	2	1	0		
			S	Z	H	OV	N	C												
Load 8-bit Data	LD A,I	11 101 101 01 010 111						S/D		2	6	I←Ar		1	1	R	OV	N	C	
	LD A,R	11 101 100 01 011 111						S/D		2	6	R←Ar		1	1	R	OV	N	C	
	LD A,(BC)	00 001 010 00 011 010					S	D		1	6	(BC) <sub>n</sub> ←Ar	⊕							
	LD A,(DE)	00 010 010 00 111 010					S	D		1	6	(DE) <sub>n</sub> ←Ar								
	LD A,(mm)	00 111 010 ( m ) ( m )		S				D		3	12	(mm) <sub>n</sub> ←Ar								
	LD LA	11 101 101 01 000 111						S/D		2	6	A←Lr								
	LD RA	11 101 101 01 001 111						S/D		2	6	A←Rr								
	LD (BC),A	00 000 010 00 010 010						D	S		1	7	A←(BC) <sub>n</sub>							
	LD (DE),A	00 010 010 00 110 010			D			D	S		1	7	A←(DE) <sub>n</sub>							
	LD (mm),A	00 110 010 ( m ) ( m )		D				S	S		3	13	A←(mm) <sub>n</sub>							
	LD r,r'	01 g g' 01 g 110					S/D			1	4	r'←rg								
	LD r,(HL)	01 g 110 00 g 110		S			D	S		1	6	(HL) <sub>n</sub> ←rg								
	LD r,m	00 g 110 ( m ) ( m )		S				D		2	6	m←rg								
	LD r,(IX+d)	11 011 101 01 g 110 ( d ) ( d )			S	D				3	14	(IX+d) <sub>n</sub> ←rg								
	LD r,(IY+d)	11 111 101 01 g 110 ( d ) ( d )			S	D				3	14	(IY+d) <sub>n</sub> ←rg								
	LD (HL),m	00 110 110 ( m ) ( m )		S				D		2	6	m←(HL) <sub>n</sub>								
	LD (IX+d),m	11 011 101 00 110 110 ( d ) ( m )		S	D					4	15	m←(IX+d) <sub>n</sub>								
	LD (IY+d),m	11 111 101 00 110 110 ( d ) ( m )		S	D					4	15	m←(IY+d) <sub>n</sub>								
	LD (HL),g	01 110 g 11 011 101			D	S	D			1	7	g←(HL) <sub>n</sub>								
	LD (IX+d),g	01 110 g ( d ) ( d )			D	S				1	15	g←(IX+d) <sub>n</sub>								
	LD (IY+d),g	11 111 101 01 110 g ( d ) ( d )			D	S				3	15	g←(IY+d) <sub>n</sub>								

⊕ In the case of R1 and Z Mask, interrupts are not sampled at the end of LD A, I or LD A, R.

(2) 16-Bit Load

Operation name	MNEMONICS	OP code	Addressing						Bytes	Status	Operation	Flag									
			ADDRESS	EXT	IND	REG	RNG	DIP				REL	7	6	4	2	1	0			
													S	Z	N	P/V	N	C			
Load 16-bit Data	LD <i>rr</i> , <i>mm</i>	01 000 001 ( r ) ( m )	S			D				3	0	<i>mm</i> → <i>rr</i> <sub>0</sub>	.	.	.	.	.	.	.		
	LD <i>IX</i> , <i>mm</i>	11 011 101 00 100 001 ( r ) ( m )	S					D		4	12	<i>mm</i> → <i>IX</i> <sub>0</sub>	.	.	.	.	.	.	.		
	LD <i>IX</i> , <i>mm</i>	11 111 101 00 100 001 ( r ) ( m )	S					D		4	12	<i>mm</i> → <i>IX</i> <sub>1</sub>	.	.	.	.	.	.	.	.	
	LD <i>SP</i> , <i>HL</i>	11 111 001						S/D		1	4	<i>HL</i> <sub>0</sub> → <i>SP</i> <sub>0</sub>	.	.	.	.	.	.	.	.	
	LD <i>SP</i> , <i>IX</i>	11 011 100						S/D		2	7	<i>IX</i> <sub>0</sub> → <i>SP</i> <sub>0</sub>	.	.	.	.	.	.	.	.	
	LD <i>SP</i> , <i>IY</i>	11 111 000							S/D		2	7	<i>IY</i> <sub>0</sub> → <i>SP</i> <sub>0</sub>	.	.	.	.	.	.	.	.
	LD <i>rr</i> ,( <i>mm</i> )	11 101 101 01 001 011 ( r ) ( m )		S			D			4	10	<i>(mm+1)</i> <sub>0</sub> → <i>rr</i> <sub>0</sub> <i>(mm)</i> <sub>0</sub> → <i>rr</i> <sub>1</sub>	.	.	.	.	.	.	.	.	
	LD <i>HL</i> ,( <i>mm</i> )	00 101 010 ( r ) ( m )		S				D		3	15	<i>(mm+1)</i> <sub>0</sub> → <i>HL</i> <sub>0</sub> <i>(mm)</i> <sub>0</sub> → <i>HL</i> <sub>1</sub>	.	.	.	.	.	.	.	.	
	LD <i>IX</i> ,( <i>mm</i> )	11 011 101 00 101 010 ( r ) ( m )		S					D	4	10	<i>(mm+1)</i> <sub>0</sub> → <i>IX</i> <sub>0</sub> <i>(mm)</i> <sub>0</sub> → <i>IX</i> <sub>1</sub>	.	.	.	.	.	.	.	.	
	LD <i>IY</i> ,( <i>mm</i> )	11 111 101 00 101 010 ( r ) ( m )		S					D	4	10	<i>(mm+1)</i> <sub>0</sub> → <i>IY</i> <sub>0</sub> <i>(mm)</i> <sub>0</sub> → <i>IY</i> <sub>1</sub>	.	.	.	.	.	.	.	.	
	LD ( <i>mm</i> ), <i>rr</i>	11 101 100 01 000 011 ( r ) ( m )			D	S				4	10	<i>rr</i> <sub>0</sub> → <i>(mm+1)</i> <sub>0</sub> <i>rr</i> <sub>1</sub> → <i>(mm)</i> <sub>0</sub>	.	.	.	.	.	.	.	.	
	LD ( <i>mm</i> ), <i>HL</i>	00 100 010 ( r ) ( m )			D			S		3	15	<i>HL</i> <sub>0</sub> → <i>(mm+1)</i> <sub>0</sub> <i>HL</i> <sub>1</sub> → <i>(mm)</i> <sub>0</sub>	.	.	.	.	.	.	.	.	
	LD ( <i>mm</i> ), <i>IX</i>	11 011 100 00 100 010 ( r ) ( m )			D				S	4	10	<i>IX</i> <sub>0</sub> → <i>(mm+1)</i> <sub>0</sub> <i>IX</i> <sub>1</sub> → <i>(mm)</i> <sub>0</sub>	.	.	.	.	.	.	.	.	
	LD ( <i>mm</i> ), <i>IY</i>	11 111 100 00 100 010 ( r ) ( m )			D				S	4	10	<i>IY</i> <sub>0</sub> → <i>(mm+1)</i> <sub>0</sub> <i>IY</i> <sub>1</sub> → <i>(mm)</i> <sub>0</sub>	.	.	.	.	.	.	.	.	

(3) Block Transfer

Operation name	MNEMONICS	OP code	Addressing						Bytes	Status	Operation	Flag							
			DO	DI	EXT	DND	IRG	IRGI				DMP	REL	7	6	4	2	1	0
			S	Z	H	P/V	N	C											
Block Transfer Search Data	CPD	11 101 101						S	S		1	12	Ar-(HL) <sub>n</sub> BC <sub>n</sub> -1-BC <sub>n</sub> HL <sub>n</sub> -1-HL <sub>n</sub>	0	0				
		10 101 001											HL <sub>n</sub> -1-HL <sub>n</sub>						
	CPE	11 101 101						S	S		2	14	BC <sub>n</sub> +0 Ar=(HL) <sub>n</sub> BC <sub>n</sub> +0 or Ar=(HL) <sub>n</sub>	0	0				
		10 111 001											Ar-(HL) <sub>n</sub> Q BC <sub>n</sub> -1-BC <sub>n</sub> HL <sub>n</sub> -1-HL <sub>n</sub> Repeat Q until Ar=(HL) <sub>n</sub> or BC <sub>n</sub> +0						
	CPI	11 101 101						S	S		2	12	Ar-(HL) <sub>n</sub> BC <sub>n</sub> -1-BC <sub>n</sub> HL <sub>n</sub> +1-HL <sub>n</sub>	1	1	1	1	S	
		10 100 001											HL <sub>n</sub> +1-HL <sub>n</sub>						
CPE	11 101 101						S	S		2	14	BC <sub>n</sub> +0 Ar=(HL) <sub>n</sub> BC <sub>n</sub> +0 or Ar=(HL) <sub>n</sub>	1	1	1	1	S		
	10 110 001											Ar-(HL) <sub>n</sub> Q BC <sub>n</sub> -1-BC <sub>n</sub> HL <sub>n</sub> +1-HL <sub>n</sub> Repeat Q until Ar=(HL) <sub>n</sub> or BC <sub>n</sub> +0							
LDD	11 101 101 10 101 000							S/D		2	12	(HL) <sub>n</sub> -(DE) <sub>n</sub> BC <sub>n</sub> -1-BC <sub>n</sub> DE <sub>n</sub> -1-DE <sub>n</sub> HL <sub>n</sub> -1-HL <sub>n</sub>			R		R		
								S/D		2	14 (BC <sub>n</sub> +0) 12 (BC <sub>n</sub> +0)	(HL) <sub>n</sub> -(DE) <sub>n</sub> Q BC <sub>n</sub> -1-BC <sub>n</sub> DE <sub>n</sub> -1-DE <sub>n</sub> HL <sub>n</sub> -1-HL <sub>n</sub> Repeat Q until BC <sub>n</sub> +0				R	R	R	
LDI	11 101 101 10 100 000							S/D		3	12	(HL) <sub>n</sub> -(DE) <sub>n</sub> BC <sub>n</sub> -1-BC <sub>n</sub> DE <sub>n</sub> +1-DE <sub>n</sub> HL <sub>n</sub> +1-HL <sub>n</sub>				R		R	
								S/D		2	14 (BC <sub>n</sub> +0) 12 (BC <sub>n</sub> +0)	(HL) <sub>n</sub> -(DE) <sub>n</sub> Q BC <sub>n</sub> -1-BC <sub>n</sub> DE <sub>n</sub> +1-DE <sub>n</sub> HL <sub>n</sub> +1-HL <sub>n</sub> Repeat Q until BC <sub>n</sub> +0					R	R	

- ⊙ P/V=0 : BC<sub>n</sub>-1=0  
P/V=1 : BC<sub>n</sub>-1=0
- ⊙ Z=1 : Ar=(HL)<sub>n</sub>  
Z=0 : Ar=(HL)<sub>n</sub>

เอกสารนี้เป็นเอกสารที่สงวนไว้สำหรับการใช้งาน 170 ารศึกษาเท่านั้น ไม่อนุญาตให้นำไปใช้ประโยชน์ด้านการค้า  
ไม่ว่ากรณีใดๆทั้งสิ้น อีกทั้งห้ามมิให้ตัดแปลงเนื้อหา และต้องอ้างอิงถึงเจ้าของเอกสารทุกครั้งที่มีการนำไปใช้

(4) Stack and Exchange

Operation name	MNEMONICS	OP code	Addressing						Bytes	Status	Operation	Flag							
			IMM	EXT	D/D	REG	REG	IMP				REL	T	Z	H	P/V	N	C	
PUSH	PUSH AX	11 00 101				S		D		1	11	AX ← (SP - 2) <sub>0</sub> AX ← (SP - 1) <sub>0</sub> SP ← SP - 2							
	PUSH BX	11 011 101 11 100 101						S/D		2	14	BX ← (SP - 2) <sub>0</sub> BX ← (SP - 1) <sub>0</sub> SP ← SP - 2							
	PUSH CX	11 111 101 11 100 101						S/D		2	14	CX ← (SP - 2) <sub>0</sub> CX ← (SP - 1) <sub>0</sub> SP ← SP - 2							
POP	POP AX	11 00 001				D		S		1	9	(SP + 1) <sub>0</sub> ← AX (SP) <sub>0</sub> ← AX SP ← SP + 2	⊙						
	POP BX	11 011 001 11 100 001						S/D		2	12	(SP + 1) <sub>0</sub> ← BX (SP) <sub>0</sub> ← BX SP ← SP + 2							
	POP CX	11 111 001 11 100 001						S/D		2	12	(SP + 1) <sub>0</sub> ← CX (SP) <sub>0</sub> ← CX SP ← SP + 2							
Exchange	EX AX,AX	00 001 000						S/D		1	4	AX ← AX							
	EX DE,DI	11 101 011						S/D		1	3	DI ← DI							
	EX	11 011 001						S/D		1	3	SI ← SI							
	EX (SI),DI	11 100 011						S/D		1	10	DI ← (SI)							
	EX (SI),SI	11 011 101						S/D		2	10	SI ← (SI)							
	EX (SI),DI	11 100 011						S/D		2	10	DI ← (SI)							
	EX (SI),SI	11 111 101						S/D		2	10	SI ← (SI)							

⊙ In the case of POP AX, Flag is written a current contents of the stack.



### 3. Program Control Instructions

Operation name	MONEMONICS	OP code	Addressing							Bytes	Status	Operation	Flag							
			DDZZ	EXT	DVD	IRG	RRCZ	DIP	REL				7	6	4	2	1	0		
Call	CALL m	11 001 00 ( n ) ( m )		D							3	16	PC <sub>0</sub> ← (SP-1) <sub>0</sub> PC <sub>1</sub> ← (SP-1) <sub>1</sub> m → PC <sub>0</sub> SP <sub>0</sub> ← SP <sub>0</sub> continue: f is false CALL m: f is true	.	.	.	.	.	.	
	CALL Imm	11 1 00 ( n ) ( m )		D							3	6 (f: false) 10 (f: true)	imm → PC <sub>0</sub> : f is true continue: f is false CALL imm: f is true	.	.	.	.	.	.	
Jump	DNZ j	00 010 000 (s)							D		2	9 (Dr=0) 7 (Dr=0)	Dr ← 1 - Dr continue: Dr=0 PC <sub>0</sub> ← j - PC <sub>0</sub> : Dr=0	.	.	.	.	.	.	
	JP Imm	11 1 00 ( n ) ( m )		D							3	6 (f: false) 9 (f: true)	imm → PC <sub>0</sub> : f is true continue: f is false	.	.	.	.	.	.	
	JP m	11 000 011 ( n ) ( m )		D							3	9	m → PC <sub>0</sub>	.	.	.	.	.	.	
	JP (RL)	11 100 001						D			1	3	RL <sub>0</sub> → PC <sub>0</sub>	.	.	.	.	.	.	
	JP (RD)	11 011 100						D			2	6	RL <sub>1</sub> → PC <sub>0</sub>	.	.	.	.	.	.	
	JP (RY)	11 111 100						D			2	6	RY <sub>0</sub> → PC <sub>0</sub>	.	.	.	.	.	.	
	JR j	00 011 000 (s)							D			2	8	PC <sub>0</sub> ← j - PC <sub>0</sub>	.	.	.	.	.	.
	JR CJ	00 111 000 (s)							D			2	6	continue: C=0	.	.	.	.	.	.
	JR NCJ	00 110 000 (s)							D			2	6	PC <sub>0</sub> ← j - PC <sub>0</sub> : C=1 continue: C=1	.	.	.	.	.	.
	JR ZJ	00 101 000 (s)							D			2	6	PC <sub>0</sub> ← j - PC <sub>0</sub> : Z=0 continue: Z=0	.	.	.	.	.	.
	JR NZJ	00 100 000 (s)							D			2	6	PC <sub>0</sub> ← j - PC <sub>0</sub> : Z=1 continue: Z=1	.	.	.	.	.	.
	JR CJ	00 111 000 (s)							D			2	6	PC <sub>0</sub> ← j - PC <sub>0</sub> : Z=C	.	.	.	.	.	.
	Return	RET	11 001 001							D		1	9	SP <sub>0</sub> ← PC <sub>0</sub> SP ← SP <sub>0</sub> - PC <sub>0</sub> SP <sub>0</sub> ← SP <sub>0</sub> continue: f is false RET: f is true	.	.	.	.	.	.
		RET f	11 1 000							D		1	5 (f: false) 10 (f: true)	continue: f is false RET: f is true	.	.	.	.	.	.
RETI		11 101 101 01 001 101							D		2	13 (no. R1) 20 (Z)	SP <sub>0</sub> ← PC <sub>0</sub> SP ← SP <sub>0</sub> - PC <sub>0</sub> SP <sub>0</sub> ← SP <sub>0</sub> continue: f is false RETI: f is true	.	.	.	.	.	.	
RETN		11 101 100 01 000 100							D		2	13	SP <sub>0</sub> ← PC <sub>0</sub> SP ← SP <sub>0</sub> - PC <sub>0</sub> SP <sub>0</sub> ← SP <sub>0</sub> continue: f is false RETN: f is true	.	.	.	.	.	.	
Restart	RET r	11 r 111							D		1	11	PC <sub>0</sub> ← (SP-1) <sub>0</sub> PC <sub>1</sub> ← (SP-1) <sub>1</sub> r → PC <sub>0</sub> SP <sub>0</sub> ← SP <sub>0</sub>	.	.	.	.	.	.	

เอกสารนี้เป็นเอกสารที่สงวนไว้สำหรับการใช้งานเพื่อการศึกษาเท่านั้น ไม่อนุญาตให้นำไปใช้ประโยชน์ด้านการค้า  
ไม่ว่ากรณีใดๆทั้งสิ้น อีกทั้งห้ามมิให้ดัดแปลงเนื้อหา 172 ต้องอ้างอิงถึงเจ้าของเอกสารทุกครั้งที่มีการนำไปใช้

#### 4. I/O Instructions

Operation name	MNEMONICS	OP code	Addressing							Bytes	Status	Operation	Flags					
			IMMED	EXT	IND	REG	RXC	DMP	REL				7	6	4	2	1	0
													S	Z	H	P/V	N	C
INPUT	IN A.(m)	11 011 011 ( m )						D	S	2	9	(Acc) ← Ar m ← A <sub>n</sub> - A <sub>n</sub>	.	.	.	.	.	.
	IN g.(C)	11 101 101 00 g 000					D		S	2	9	Ar ← A <sub>n</sub> - A <sub>n</sub> (BC) ← g g = 110 Only the flag will change. Cr ← A <sub>n</sub> - A <sub>n</sub> Br ← A <sub>n</sub> - A <sub>n</sub> (Hls) ← g g = 110 Only the flag will change. m ← A <sub>n</sub> - A <sub>n</sub> @ ← A <sub>n</sub> - A <sub>n</sub>	I	I	R	P	R	.
	IN g.(m)	11 101 101 00 g 000 ( m )					D		S	3	12	(Hls) ← g g = 110 Only the flag will change. m ← A <sub>n</sub> - A <sub>n</sub> @ ← A <sub>n</sub> - A <sub>n</sub>	I	I	R	P	R	.
	IND	11 101 101 10 101 010					D		S	3	12	(BC) ← HL <sub>n</sub> HL <sub>n</sub> ← HL <sub>n</sub> Br ← Br Cr ← A <sub>n</sub> - A <sub>n</sub> Br ← A <sub>n</sub> - A <sub>n</sub>	X	1	X	X	1	X
	INDE	11 101 101 10 111 010					D		S	3	14 (Br=0) 12 (Br=1)	(BC) ← HL <sub>n</sub> Q: HL <sub>n</sub> ← HL <sub>n</sub> Br ← Br Request Q used Br = 0 Cr ← A <sub>n</sub> - A <sub>n</sub> Br ← A <sub>n</sub> - A <sub>n</sub>	X	S	X	X	1	X
	INI	11 101 101 10 100 010					D		S	2	12	(BC) ← HL <sub>n</sub> HL <sub>n</sub> ← HL <sub>n</sub> Br ← Br Cr ← A <sub>n</sub> - A <sub>n</sub> Br ← A <sub>n</sub> - A <sub>n</sub>	X	1	X	X	1	X
INIE	11 101 101 10 110 010					D		S	2	14 (Br=0) 12 (Br=1)	(BC) ← HL <sub>n</sub> Q: HL <sub>n</sub> ← HL <sub>n</sub> Br ← Br Request Q used Br = 1 Cr ← A <sub>n</sub> - A <sub>n</sub> Br ← A <sub>n</sub> - A <sub>n</sub>	X	S	X	X	1	X	

- ⊙ Z=1: Br=1=0
- Z=0: Br=1=0
- ⊙ N=1: MSB of Data=1
- N=0: MSB of Data=0

to be continued

Operation name	MNEMONICS	OP code	Addressing					Bytem	Status	Operation	Flag										
			IMMED	EXT	DND	REG	REG				DMP	REL	S	Z	N	P/V	N	C			
OUTPUT	OUT (m)A ( m )	11 010 001					S	D	2	10	A←(Am), B←A-A	.	.	.	.	.	.	.	.	.	.
	OUT (C)g 01 g 001	11 101 101					S	D	2	10	A←A-A g←(BC), C←A-A	.	.	.	.	.	.	.	.	.	.
	OUTV (m)g ** 00 g 000 ( m )	11 101 101					S	D	3	13	B←A-A g←(Bm), B←A-A	.	.	.	.	.	.	.	.	.	.
	OTDM ** 11 001 101 10 001 011	11 001 101					S	D	2	14	B←A-A (HL) <sub>0</sub> ←(BC), HL <sub>0</sub> ←1-HL <sub>0</sub> C←1-C B←1-B C←A-A	1	1	.	.	P	.	.	.	.	
	OTDMR ** 11 101 101 10 011 011	11 101 101					S	D	2	10(Br=0) 14(Br=0)	(HL) <sub>0</sub> ←(BC), HL <sub>0</sub> ←1-HL <sub>0</sub> Q C←1-C B←1-B Repeat Q until Br=0 C←A-A B←A-A	R	S	R	S	.	.	.	.	.	
	OTDR 11 101 101 10 111 011	11 101 101					S	D	2	14(Br=0) 12(Br=0)	(HL) <sub>0</sub> ←(BC), Q HL <sub>0</sub> ←1-HL <sub>0</sub> B←1-B Repeat Q until Br=0 C←A-A B←A-A	X	S	X	X	.	.	.	.	.	
	OUTI 11 101 101 10 100 011	11 101 101					S	D	2	12	(HL) <sub>0</sub> ←(BC), HL <sub>0</sub> ←1-HL <sub>0</sub> B←1-B C←A-A	X	1	X	X	.	.	.	.	.	
	OTIR 11 101 101 10 110 011	11 101 101					S	D	2	14(Br=0) 12(Br=0)	(HL) <sub>0</sub> ←(BC), Q HL <sub>0</sub> ←1-HL <sub>0</sub> B←1-B Repeat Q until Br=0 C←A-A B←A-A	X	S	X	X	.	.	.	.	.	
	TSTD m ** 11 101 101 01 110 100 ( m )	11 101 101	S					S	3	12	(C)←m C←A-A B←A-A	1	.	.	S	P	R	R	.	.	
	OTIM ** 11 101 101 10 000 011	11 101 101					S	D	2	14	(HL) <sub>0</sub> ←(BC), HL <sub>0</sub> ←1-HL <sub>0</sub> C←1-C B←1-B C←A-A B←A-A	1	.	.	P	.	.	.	.		
	OTIMR ** 11 101 101 10 010 011	11 101 101					S	D	2	14(Br=0) 14(Br=0)	(HL) <sub>0</sub> ←(BC), HL <sub>0</sub> ←1-HL <sub>0</sub> Q C←1-C B←1-B Repeat Q until Br=0 C←A-A B←A-A	R	S	R	S	.	.	.	.		
	OUTD 11 101 101 10 101 011	11 101 101					S	D	2	12	(HL) <sub>0</sub> ←(BC), HL <sub>0</sub> ←1-HL <sub>0</sub> B←1-B C←A-A	X	1	X	X	.	.	.	.	.	

⊙ Z=1: Br=1=0  
Z=0: Br=1=0  
⊙ N=1: MSB of Data=1  
N=0: MSB of Data=0

### 5. Special Control Instructions

Operation name	MNEMONICS	OP code	Addressing							Bytes	Status	Operation	Flag													
			IMMEDI	EXT	DND	REG	REG	DSP	REL				S	Z	H	P/V	N	C								
Special Function	DAA	00 100 111							S/D		1	4	Decimal Adjust Accumulator													
Carry Control	CCF	00 111 111									1	3	C←C													
	SCF	00 110 111									1	3	I←C													
CPU Control	DI	11 110 012									1	3	0-DF, 0-DF, 0													
	EI	11 111 011									1	3	1-DF, 1-DF, 0													
	HALT	00 110 110									1	3	CPU halted													
	DM 0	11 101 100										2	6	Interrupt mode 0												
	DM 1	01 000 110										2	6	Interrupt mode 1												
	DM 2	11 101 101										2	6	Interrupt mode 2												
	NOP	00 000 000										1	2	No operation												
	SLP	11 101 101										2	1	Sleep												
			01 110 110										1	1												

⊙ Instructions are not sampled at the end of DI or EI.

เอกสารนี้เป็นเอกสารที่สงวนไว้สำหรับการใช้งานที่ 175 ศึกษานี้เท่านั้น ไม่อนุญาตให้นำไปใช้ประโยชน์ด้านการค้า  
ไม่ว่ากรณีใดๆทั้งสิ้น อีกทั้งห้ามมิให้ดัดแปลงเนื้อหา และต้องอ้างอิงถึงเจ้าของเอกสารทุกครั้งที่มีการนำไปใช้

## B. Instruction Summary in Alphabetical Order

\*\* : Added new instructions to Z80

MNEMONICS	Bytes	Machine Cycles	States
ADC A,m	2	2	6
ADC A,g	1	2	4
ADC A, (HL)	1	2	6
ADC A, (IX+d)	3	6	14
ADC A, (IY+d)	3	6	14
ADD A,m	2	2	6
ADD A,g	1	2	4
ADD A, (HL)	1	2	6
ADD A, (IX+d)	3	6	14
ADD A, (IY+d)	3	6	14
ADC HL,ww	2	6	10
ADD HL,ww	1	5	7
ADD IX,xx	2	6	10
ADD IY,yy	2	6	10
AND m	2	2	6
AND g	1	2	4
AND (HL)	1	2	6
AND (IX+d)	3	6	14
AND (IY+d)	3	6	14
BIT b, (HL)	2	3	9
BIT b, (IX+d)	4	5	15
BIT b, (IY+d)	4	5	15
BIT b,g	2	2	6
CALL f,mn	3	2	6
			(If condition is false)
	3	6	16
			(If condition is true)

(to be continued)

MNEMONICS	Bytes	Machine Cycles	States
CALL mn	3	6	16
CCF	1	1	3
CPD	2	6	12
CPDR	2	8	14
			(if $BC_R \neq 0$ and $Ar \neq (HL)_M$ )
	2	6	12
			(if $BC_R = 0$ or $Ar = (HL)_M$ )
CP (HL)	1	2	6
CPI	2	6	12
CPIR	2	8	14
			(if $BC_R \neq 0$ and $Ar \neq (HL)_M$ )
	2	6	12
			(if $BC_R = 0$ or $Ar = (HL)_M$ )
CP (IX+d)	3	6	14
CP (IY+d)	3	6	14
CPL	1	1	3
CP m	2	2	6
CP g	1	2	4
DAA	1	2	4
DEC (HL)	1	4	10
DEC IX	2	3	7
DEC IY	2	3	7
DEC (IX+d)	3	8	18
DEC (IY+d)	3	8	18
DEC g	1	2	4
DEC ww	1	2	4
DI	1	1	3

to be continued

MNEMONICS	Bytes	Machine Cycles	States
DJNZ j	2	5	9 (if Br≠0)
	2	3	7 (if Br=0)
EI	1	1	3
EX AF,AF'	1	2	4
EX DE,HL	1	1	3
EX (SP),HL	1	6	16
EX (SP),IX	2	7	19
EX (SP),IY	2	7	19
EXX	1	1	3
HALT	1	1	3
IM 0	2	2	6
IM 1	2	2	6
IM 2	2	2	6
INC g	1	2	4
INC (HL)	1	4	10
INC (IX+d)	3	8	18
INC (IY+d)	3	8	18
INC ww	1	2	4
INC IX	2	3	7
INC IY	2	3	7
IN A,(m)	2	3	9
IN g,(C)	2	3	9
INI	2	4	12
INIR	2	6	14 (if Br≠0)
	2	4	12 (if Br=0)
IND	2	4	12
INDR	2	6	14 (if Br≠0)

to be continued

เอกสารนี้เป็นเอกสารที่สงวนไว้สำหรับการใช้งานเพื่อการศึกษาเท่านั้น ไม่อนุญาตให้นำไปใช้ประโยชน์ด้านการค้า  
ไม่ว่ากรณีใดๆทั้งสิ้น อีกทั้งห้ามมิให้ตัดแปลงเนื้อหา และต้องอ้างอิงถึงเจ้าของเอกสารทุกครั้งที่มีการนำไปใช้

MNEMONICS	Bytes	Machine Cycles	States
INDR	2	4	12 (if Br=0)
INO g.(m)**	3	4	12
JP f,mn	3	2	6
	3	3	(if f is false) 9
			(if f is true) 3
JP (HL)	1	1	3
JP (IX)	2	2	6
JP (Y)	2	2	6
JP mn	3	3	9
JR j	2	4	8
JR C,j	2	2	6
	2	4	(if condition is false) 8
			(if condition is true) 6
JR NC,j	2	2	6
	2	4	(if condition is false) 8
			(if condition is true) 6
JR Z,j	2	2	6
	2	4	(if condition is false) 8
			(if condition is true) 6
JR NZ,j	2	2	6
	2	4	(if condition is false) 8
			(if condition is true)

to be continued

MNEMONICS	Bytes	Machine Cycles	States
LD A, (BC)	1	2	6
LD A, (DE)	1	2	6
LD A,I	2	2	6
LD A, (mn)	3	4	12
LD A,R	2	2	6
LD (BC),A	1	3	7
LDD	2	4	12
LD (DE),A	1	3	7
LD ww,mn	3	3	9
LD ww,(mn)	4	6	18
LDDR	2	6	14 (if $BC_R \neq 0$ )
	2	4	12 (if $BC_R = 0$ )
LD (HL),m	2	3	9
LD HL, (mn)	3	5	15
LD (HL),g	1	3	7
LDI	2	4	12
LD IA	2	2	6
LDIR	2	6	14 (if $BC_R \neq 0$ )
	2	4	12 (if $BC_R = 0$ )
LD IX,mn	4	4	12
LD IX, (mn)	4	6	18
LD (IX+d),m	4	5	15
LD (IX+d),g	3	7	15
LD IY,mn	4	4	12
LD IY, (mn)	4	6	18
LD (IY+d),m	4	5	15
LD (IY+d),g	3	7	15

(to be continued)

MNEMONICS	Bytes	Machine Cycles	States
LD (mn),A	3	5	13
LD (mn),ww	4	7	19
LD (mn),HL	3	6	16
LD (mn),IX	4	7	19
LD (mn),IY	4	7	19
LD R,A	2	2	6
LD g,(HL)	1	2	6
LD g,(IX+d)	3	6	14
LD g,(IY+d)	3	6	14
LD g,m	2	2	6
LD g,g'	1	2	4
LD SP,HL	1	2	4
LD SP,IX	2	3	7
LD SP,IY	2	3	7
MLT ww**	2	13	17
NEG	2	2	6
NOP	1	1	3
OR (HL)	1	2	6
OR (IX+d)	3	6	14
OR (IY+d)	3	6	14
OR m	2	2	6
OR g	1	2	4
OTDM**	2	6	14
OTDMR**	2	8	16 (if Br≠0)
	2	6	14 (if Br=0)
OTDR	2	6	14 (if Br≠0)
	2	4	12 (if Br=0)

to be continued

MNEMONICS	Bytes	Machine Cycles	States
OTIM**	2	8	14
OTIMR**	2	8	16 (if Br≠0)
	2	6	14 (if Br=0)
OTIR	2	6	14 (if Br≠0)
	2	4	12 (if Br=0)
OUTD	2	4	12
OUTI	2	4	12
OUT (m),A	2	4	10
OUT (C),g	2	4	10
OUTO (m),g**	3	5	13
POP IX	2	4	12
POP IY	2	4	12
POP zz	1	3	9
PUSH IX	2	6	14
PUSH IY	2	6	14
PUSH zz	1	5	11
RES b,(HL)	2	5	13
RES b,(X+d)	4	7	19
RES b,(Y+d)	4	7	19
RES b,g	2	3	7
RET	1	3	9
RET f	1	3	5
	1	4	(if condition is false) 10
			(if condition is true)
RETI	2	4 (RO, R1)	12 (RO, R1)
		10 (Z)	22 (Z)
RETN	2	4	12

Do not be continued

MNEMONICS	Bytes	Machine Cycles	States
RLA	1	1	3
RLCA	1	1	3
RLC (HL)	2	5	13
RLC (IX+d)	4	7	19
RLC (IY+d)	4	7	19
RLC g	2	3	7
RLD	2	8	16
RL (HL)	2	5	13
RL (IX+d)	4	7	19
RL (IY+d)	4	7	19
RL g	2	3	7
RRA	1	1	3
RRCA	1	1	3
RRC (HL)	2	5	13
RRC (IX+d)	4	7	19
RRC (IY+d)	4	7	19
RRC g	2	3	7
RRD	2	8	16
RR (HL)	2	5	13
RR (IX+d)	4	7	19
RR (IY+d)	4	7	19
RR g	2	3	7
RST v	1	5	11
SBC A,(HL)	1	2	6
SBC A,(IX+d)	3	6	14
SBC A,(IY+d)	3	6	14
SBC A,m	2	2	6

(to be continued)

เอกสารนี้เป็นเอกสารที่สงวนไว้สำหรับการใช้งานเพื่อการศึกษาเท่านั้น ไม่นอญตให้นำไปใช้ประโยชน์ด้านการค้า  
ไม่ว่ากรณีใดๆทั้งสิ้น อีกทั้งห้ามมิให้ดัดแปลงเนื้อหา และต้องอ้างอิงถึงเจ้าของเอกสารทุกครั้งที่มีการนำไปใช้

MNEMONICS	Bytes	Machine Cycles	States
SBC A,g	1	2	4
SBC HL,ww	2	6	10
SCF	1	1	3
SET b,(HL)	2	5	13
SET b,(IX+d)	4	7	19
SET b,(IY+d)	4	7	19
SET b,g	2	3	7
SLA (HL)	2	5	13
SLA (IX+d)	4	7	19
SLA (IY+d)	4	7	19
SLA g	2	3	7
SLP**	2	2	8
SRA (HL)	2	5	13
SRA (IX+d)	4	7	19
SRA (IY+d)	4	7	19
SRA g	2	3	7
SRL (HL)	2	5	13
SRL (IX+d)	4	7	19
SRL (IY+d)	4	7	19
SRL g	2	3	7
SUB (HL)	1	2	6
SUB (IX+d)	3	6	14
SUB (IY+d)	3	6	14
SUB m	2	2	6
SUB g	1	2	4
**TSTIO m	3	4	12
**TST g	2	3	7

No be continued

เอกสารนี้เป็นเอกสารที่สงวนไว้สำหรับการใช้งานเพื่อการศึกษาเท่านั้น ไม่อนุญาตให้นำไปใช้ประโยชน์ด้านการค้า  
ไม่ว่ากรณีใดๆทั้งสิ้น อีกทั้งห้ามมิให้ดัดแปลงเนื้อหา 184 และต้องอ้างอิงถึงเจ้าของเอกสารทุกครั้งที่มีการนำไปใช้

MNEMONICS	Bytes	Machine Cycles	States
TST m**	3	3	9
TST (HL)**	2	4	10
XOR (HL)	1	2	6
XOR (IX+d)	3	6	14
XOR (IY+d)	3	6	14
XOR m	2	2	6
XOR g	1	2	4

### C. Op-code Map

Table 1 1st op-code map  
Instruction format : XX

ww (LO=ALL)		g (LO=0~7)				g (LO=0~7)				LO=0~7					
BC	DE	HL	SP	B	D	H	(HL)	1000	1001	1010	1011	1100	1101	1110	1111
B	0000	0001	0010	0011	0100	0101	0110	0111	1000	1001	1010	1011	1100	1101	1111
C	0001	0010	0011	0100	0101	0110	0111	1000	1001	1010	1011	1100	1101	1110	1111
D	0010	0011	0100	0101	0110	0111	1000	1001	1010	1011	1100	1101	1110	1111	
E	0011	0100	0101	0110	0111	1000	1001	1010	1011	1100	1101	1110	1111		
H	0100	0101	0110	0111	1000	1001	1010	1011	1100	1101	1110	1111			
L	0101	0110	0111	1000	1001	1010	1011	1100	1101	1110	1111				
(HL)	0110	0111	1000	1001	1010	1011	1100	1101	1110	1111					
A	0111	1000	1001	1010	1011	1100	1101	1110	1111						
B	1000	1001	1010	1011	1100	1101	1110	1111							
C	1001	1010	1011	1100	1101	1110	1111								
D	1010	1011	1100	1101	1110	1111									
E	1011	1100	1101	1110	1111										
H	1100	1101	1110	1111											
L	1101	1110	1111												
(HL)	1110	1111													
A	1111														

Instruction	BC	DE	HL	SP	OP	OP s	OP s	OP s	OP s	OP s	OP s	OP s	OP s	OP s	OP s
LD ww, mn															
LD (ww), A															
LD (mm)															
LD (mm), A															
INC ww															
INC g															
DEC g															
LD g, m															
RLCA															
RLA															
DAA															
SOF															
EXAF, AF															
JR j, JR Z, JR C, j															
ADD HL, ww															
LD A, (ww)															
LD HL, LD A, (mm)															
DEC ww															
INC g															
DEC g															
LD g, m															
RRCA															
RRA															
OPL															
COF															
0	1	2	3	4	5	6	7	8	9	A	B	C	D	E	F
C	E	L	A	C	E	L	A	8	9	A	B	C	D	E	F
g (LO=8~F)															

Instruction	BC	DE	HL	AF	OP	OP s	OP s	OP s	OP s	OP s	OP s	OP s	OP s	OP s	OP s
POP zz															
JP f, mn															
JP mn															
OUT (m)															
EX (SP)															
.A															
.HL															
CALL f, mn															
PUSH zz															
ADD A, m															
SUB m															
AND m															
OR m															
RST v															
RET f															
RET															
EXX															
JP (HL)															
LD SP, HL															
JP f, mn															
Table2															
IN A, (m)															
EX DE, HL															
EI															
Table3															
NOTE3															
CALL mn															
ADC A, m															
SBC A, m															
XOR m															
CP m															
RST v															
C	D	E	F	C	D	E	F	C	D	E	F	C	D	E	F
Z	C	PE	M	Z	C	PE	M	Z	C	PE	M	Z	C	PE	M
0BH	18H	28H	38H	0BH	18H	28H	38H	0BH	18H	28H	38H	0BH	18H	28H	38H
LO=8~F															

NOTE1) (HL) replaces g.

2) (HL) replaces s.

3) If DDH is supplemented as 1st op-code for the instructions which have HL or (HL) as an operand in Table 1, the instructions are executed replacing HL with IX and (HL) with (IX+d).

ex. 22H : LD (mn), HL

DDH 22H : LD (mn), IX

If FDH is supplemented as 1st op-code for the instructions which have HL or (HL) as an operand in Table 1, the instructions are executed replacing HL with IY and (HL) with (IY+d).

ex. 34H : INC (HL)

FDH 34H : INC (IY+d)

However, JP (HL) and EX DE, HL are exception and note the followings.

If DDH is supplemented as 1st op-code for JP (HL), (IX) replaces (HL) as operand and JP (IX) is executed.

If FDH is supplemented as 1st op-code for JP (HL), (IY) replaces (HL) as operand and JP (IY) is executed.

Even if DDH or FDH is supplemented as 1st op-code for EX DE, HL, HL is not replaced and the instruction is regarded as legal instruction.





Table 3 2nd op-code map

Instruction format : ED XX

		g (LO=0~7)							ww (LO=ALL)								
		B	D	H	B	D	H	BC	DE	HL	SP						
HI	0000	0001	0010	0011	0100	0101	0110	0111	1000	1001	1010	1011	1100	1101	1110	1111	
LO	0	1	2	3	4	5	6	7	8	9	A	B	C	D	E	F	
0000	0	IN0 g.(m)							IN g.(C)				LDI	LDIR			
0001	1	OUT0 (m).g							OUT (C).g				CPI	CPDR			
0010	2								SBC HL, ww				INI	INIR			
0011	3								LD (mn), ww				OTIM	OTIMR	OUTI	OTIR	
0100	4	TST g	TST (HL)			NEG		TST m				TST0 m					
0101	5								RETN								
0110	6								IM 0				IM 1				
0111	7								LDIA				LD A1				
1000	8	IN0 g.(m)							IN g.(C)				LDD	LDDR			
1001	9	OUT0 (m).g							OUT (C).g				CPD	CPDR			
1010	A								ADC HL, ww				IND	INDR			
1011	B								LD ww, (mn)				OTDM	OTDMR	OUTD	OTDR	
1100	C	TST g							MLT ww								
1101	D								RETI								
1110	E								IM 2								
1111	F	LDRA	LDAR	RLD					8	9	A	B	C	D	E	F	
		0	1	2	3	4	5	6	7	8	9	A	B	C	D	E	F
		C	E	L	A	C	E	L	A								
		g (LO=8~F)															

### D. Bus and Control Signal Condition in each Machine Cycle

\* (ADDRESS) : invalid  
 Z (DATA) : high impedance.  
 \*\* : added new instructions to Z80

Instruction	Machine Cycle	States	ADDRESS	DATA	$\overline{RD}$	$\overline{WR}$	$\overline{MREQ}$	$\overline{IOR\overline{O}}$	$\overline{M\overline{I}}$	$\overline{HALT}$	ST
ADD HL,ww	MC <sub>1</sub>	T <sub>1</sub> T <sub>2</sub> T <sub>3</sub>	1st op-code Address	1st op-code	0	1	0	1	0	1	0
	MC <sub>2</sub>			Z	1	1	1	1	1	1	1
	-MC <sub>3</sub>	T <sub>1</sub> T <sub>2</sub> T <sub>3</sub>									
ADD IX,xx ADD IY,yy	MC <sub>1</sub>	T <sub>1</sub> T <sub>2</sub> T <sub>3</sub>	1st op-code Address	1st op-code	0	1	0	1	0	1	0
	MC <sub>2</sub>	T <sub>1</sub> T <sub>2</sub> T <sub>3</sub>	2nd op-code Address	2nd op-code	0	1	0	1	0	1	1
	MC <sub>3</sub> -MC <sub>6</sub>	T <sub>1</sub> T <sub>2</sub> T <sub>3</sub>		Z	1	1	1	1	1	1	1
ADC HL,ww SBC HL,ww	MC <sub>1</sub>	T <sub>1</sub> T <sub>2</sub> T <sub>3</sub>	1st op-code Address	1st op-code	0	1	0	1	0	1	0
	MC <sub>2</sub>	T <sub>1</sub> T <sub>2</sub> T <sub>3</sub>	2nd op-code Address	2nd op-code	0	1	0	1	0	1	1
	MC <sub>3</sub> -MC <sub>6</sub>	T <sub>1</sub> T <sub>2</sub> T <sub>3</sub>		Z	1	1	1	1	1	1	1
ADD A,g ADC A,g SUB g SBC A,g AND g OR g XOR g CP g	MC <sub>1</sub>	T <sub>1</sub> T <sub>2</sub> T <sub>3</sub>	1st op-code Address	1st op-code	0	1	0	1	0	1	0
	MC <sub>2</sub>	T <sub>1</sub>		Z	1	1	1	1	1	1	1
ADD A,m ADC A,m SUB m SBC A,m AND m OR m XOR m CP m	MC <sub>1</sub>	T <sub>1</sub> T <sub>2</sub> T <sub>3</sub>	1st op-code Address	1st op-code	0	1	0	1	0	1	0
	MC <sub>2</sub>	T <sub>1</sub> T <sub>2</sub> T <sub>3</sub>	1st operand Address	m	0	1	0	1	1	1	1
ADD A,(HL) ADC A,(HL) SUB (HL) SBC A,(HL) AND (HL) OR (HL) XOR (HL) CP (HL)	MC <sub>1</sub>	T <sub>1</sub> T <sub>2</sub> T <sub>3</sub>	1st op-code Address	1st op-code	0	1	0	1	0	1	0
	MC <sub>2</sub>	T <sub>1</sub> T <sub>2</sub> T <sub>3</sub>	HL	DATA	0	1	0	1	1	1	1
ADD A,(IX+d) ADD A,(IY+d) ADC A,(IX+d) ADC A,(IY+d) SUB (IX+d) SUB (IY+d) SBC A,(IX+d)	MC <sub>1</sub>	T <sub>1</sub> T <sub>2</sub> T <sub>3</sub>	1st op-code Address	1st op-code	0	1	0	1	0	1	0
	MC <sub>2</sub>	T <sub>1</sub> T <sub>2</sub> T <sub>3</sub>	2nd op-code Address	2nd op-code	0	1	0	1	0	1	1

(to be continued)

Instruction	Machine Cycle	States	ADDRESS	DATA	$\overline{RD}$	$\overline{WR}$	$\overline{MREQ}$	$\overline{IORQ}$	$\overline{MI}$	$\overline{HALT}$	ST
SBC A, (Y+d) AND (X+d) AND (Y+d) OR (X+d) OR (Y+d) XOR (X+d) XOR (Y+d) CP (X+d) CP (Y+d)	MC <sub>1</sub>	T <sub>1</sub> T <sub>2</sub> T <sub>3</sub>	1st operand Address	d	0	1	0	1	1	1	1
	MC <sub>2</sub> ~MC <sub>3</sub>	TTT	.	Z	1	1	1	1	1	1	1
	MC <sub>3</sub>	T <sub>1</sub> T <sub>2</sub> T <sub>3</sub>	(X+d) (Y+d)	DATA	0	1	0	1	1	1	1
BIT b,g	MC <sub>1</sub>	T <sub>1</sub> T <sub>2</sub> T <sub>3</sub>	1st op-code Address	1st op-code	0	1	0	1	0	1	0
	MC <sub>2</sub>	T <sub>1</sub> T <sub>2</sub> T <sub>3</sub>	2nd op-code Address	2nd op-code	0	1	0	1	0	1	1
BIT b, (HL)	MC <sub>1</sub>	T <sub>1</sub> T <sub>2</sub> T <sub>3</sub>	1st op-code Address	1st op-code	0	1	0	1	0	1	0
	MC <sub>2</sub>	T <sub>1</sub> T <sub>2</sub> T <sub>3</sub>	2nd op-code Address	2nd op-code	0	1	0	1	0	1	1
	MC <sub>3</sub>	T <sub>1</sub> T <sub>2</sub> T <sub>3</sub>	HL	DATA	0	1	0	1	1	1	1
BIT b, (X+d) BIT b, (Y+d)	MC <sub>1</sub>	T <sub>1</sub> T <sub>2</sub> T <sub>3</sub>	1st op-code Address	1st op-code	0	1	0	1	0	1	0
	MC <sub>2</sub>	T <sub>1</sub> T <sub>2</sub> T <sub>3</sub>	2nd op-code Address	2nd op-code	0	1	0	1	0	1	1
	MC <sub>3</sub>	T <sub>1</sub> T <sub>2</sub> T <sub>3</sub>	1st operand Address	d	0	1	0	1	1	1	1
	MC <sub>4</sub>	T <sub>1</sub> T <sub>2</sub> T <sub>3</sub>	3rd op-code Address	3rd op-code	0	1	0	1	0	1	1
	MC <sub>5</sub>	T <sub>1</sub> T <sub>2</sub> T <sub>3</sub>	(X+d) (Y+d)	DATA	0	1	0	1	1	1	1
CALL mn	MC <sub>1</sub>	T <sub>1</sub> T <sub>2</sub> T <sub>3</sub>	1st op-code Address	1st op-code	0	1	0	1	0	1	0
	MC <sub>2</sub>	T <sub>1</sub> T <sub>2</sub> T <sub>3</sub>	1st operand Address	n	0	1	0	1	1	1	1
	MC <sub>3</sub>	T <sub>1</sub> T <sub>2</sub> T <sub>3</sub>	2nd operand Address	m	0	1	0	1	1	1	1
	MC <sub>4</sub>	T <sub>1</sub>	.	Z	1	1	1	1	1	1	1
	MC <sub>5</sub>	T <sub>1</sub> T <sub>2</sub> T <sub>3</sub>	SP-1	PCH	1	0	0	1	1	1	1
	MC <sub>6</sub>	T <sub>1</sub> T <sub>2</sub> T <sub>3</sub>	SP-2	PCL	1	0	0	1	1	1	1
CALL f,mn (if condition is false)	MC <sub>1</sub>	T <sub>1</sub> T <sub>2</sub> T <sub>3</sub>	1st op-code Address	1st op-code	0	1	0	1	0	1	0
	MC <sub>2</sub>	T <sub>1</sub> T <sub>2</sub> T <sub>3</sub>	1st operand Address	n	0	1	0	1	1	1	1

Instruction	Machine Cycle	Status	ADDRESS	DATA	$\overline{RD}$	$\overline{WR}$	$\overline{MREQ}$	$\overline{IO/\overline{O}}$	$\overline{INT}$	$\overline{HALT}$	ST
CALL f,m (if condition is true)	MC <sub>1</sub>	T <sub>1</sub> T <sub>2</sub> T <sub>3</sub>	1st op-code Address	1st op-code	0	1	0	1	0	1	0
	MC <sub>2</sub>	T <sub>1</sub> T <sub>2</sub> T <sub>3</sub>	1st operand Address	n	0	1	0	1	1	1	1
	MC <sub>3</sub>	T <sub>1</sub> T <sub>2</sub> T <sub>3</sub>	2nd operand Address	m	0	1	0	1	1	1	1
	MC <sub>4</sub>	T <sub>1</sub>	.	Z	1	1	1	1	1	1	1
	MC <sub>5</sub>	T <sub>1</sub> T <sub>2</sub> T <sub>3</sub>	SP-1	PCH	1	0	0	1	1	1	1
	MC <sub>6</sub>	T <sub>1</sub> T <sub>2</sub> T <sub>3</sub>	SP-2	PCL	1	0	0	1	1	1	1
CCF	MC	T <sub>1</sub> T <sub>2</sub> T <sub>3</sub>	1st op-code Address	1st op-code	0	1	0	1	0	1	0
CPI CPD	MC <sub>1</sub>	T <sub>1</sub> T <sub>2</sub> T <sub>3</sub>	1st op-code Address	1st op-code	0	1	0	1	0	1	0
	MC <sub>2</sub>	T <sub>1</sub> T <sub>2</sub> T <sub>3</sub>	2nd op-code Address	2nd op-code	0	1	0	1	0	1	1
	MC <sub>3</sub>	T <sub>1</sub> T <sub>2</sub> T <sub>3</sub>	HL	DATA	0	1	0	1	1	1	1
	MC <sub>4</sub> -MC <sub>6</sub>	TTTTT <sub>1</sub>	.	Z	1	1	1	1	1	1	1
CPIR CPDR if BC <sub>0</sub> =0 and Ar=HLW	MC <sub>1</sub>	T <sub>1</sub> T <sub>2</sub> T <sub>3</sub>	1st op-code Address	1st op-code	0	1	0	1	0	1	0
	MC <sub>2</sub>	T <sub>1</sub> T <sub>2</sub> T <sub>3</sub>	2nd op-code Address	2nd op-code	0	1	0	1	0	1	1
	MC <sub>3</sub>	T <sub>1</sub> T <sub>2</sub> T <sub>3</sub>	HL	DATA	0	1	0	1	1	1	1
	MC <sub>4</sub> -MC <sub>6</sub>	TTTTT <sub>1</sub>	.	Z	1	1	1	1	1	1	1
CPIR CPDR if BC <sub>0</sub> =0 or Ar=HLW	MC <sub>1</sub>	T <sub>1</sub> T <sub>2</sub> T <sub>3</sub>	1st op-code Address	1st op-code	0	1	0	1	0	1	0
	MC <sub>2</sub>	T <sub>1</sub> T <sub>2</sub> T <sub>3</sub>	2nd op-code Address	2nd op-code	0	1	0	1	0	1	1
	MC <sub>3</sub>	T <sub>1</sub> T <sub>2</sub> T <sub>3</sub>	HL	DATA	0	1	0	1	1	1	1
	MC <sub>4</sub> -MC <sub>6</sub>	TTTTT <sub>1</sub>	.	Z	1	1	1	1	1	1	1
CPL	MC <sub>1</sub>	T <sub>1</sub> T <sub>2</sub> T <sub>3</sub>	1st op-code Address	1st op-code	0	1	0	1	0	1	0
DAA	MC <sub>1</sub>	T <sub>1</sub> T <sub>2</sub> T <sub>3</sub>	1st op-code Address	1st op-code	0	1	0	1	0	1	0
	MC <sub>2</sub>	T <sub>1</sub>	.	Z	1	1	1	1	1	1	1
DI+1	MC <sub>1</sub>	T <sub>1</sub> T <sub>2</sub> T <sub>3</sub>	1st op-code Address	1st op-code	0	1	0	1	0	1	0

\*1 Interrupt request is not sampled

to be continued

Instruction	Machine Cycle	States	ADDRESS	DATA	$\overline{RD}$	$\overline{WR}$	$\overline{MREQ}$	$\overline{IORQ}$	$\overline{MT}$	$\overline{HALT}$	ST
DJNZ j (If Br ≠ 0)	MC <sub>1</sub>	T <sub>1</sub> T <sub>2</sub> T <sub>3</sub>	1st op-code Address	1st op-code	0	1	0	1	0	1	0
	MC <sub>2</sub>	T <sub>1</sub> *2	*	Z	1	1	1	1	1	1	1
	MC <sub>3</sub>	T <sub>1</sub> T <sub>2</sub> T <sub>3</sub>	1st operand Address	j-2	0	1	0	1	1	1	1
	MC <sub>4</sub> ~MC <sub>5</sub>	T <sub>1</sub> T <sub>1</sub>	*	Z	1	1	1	1	1	1	1
DJNZ j (If Br = 0)	MC <sub>1</sub>	T <sub>1</sub> T <sub>2</sub> T <sub>3</sub>	1st op-code Address	1st op-code	0	1	0	1	0	1	0
	MC <sub>2</sub>	T <sub>1</sub> *1	*	Z	1	1	1	1	1	1	1
	MC <sub>3</sub>	T <sub>1</sub> T <sub>2</sub> T <sub>3</sub>	1st operand Address	j-2	0	1	0	1	1	1	1
EI*3	MC <sub>1</sub>	T <sub>1</sub> T <sub>2</sub> T <sub>3</sub>	1st op-code Address	1st op-code	0	1	0	1	0	1	0
EX DE, HL EXX	MC <sub>1</sub>	T <sub>1</sub> T <sub>2</sub> T <sub>3</sub>	1st op-code Address	1st op-code	0	1	0	1	0	1	0
EX AF, AF	MC <sub>1</sub>	T <sub>1</sub> T <sub>2</sub> T <sub>3</sub>	1st op-code Address	1st op-code	0	1	0	1	0	1	0
	MC <sub>2</sub>	T <sub>1</sub>	*	Z	1	1	1	1	1	1	1
EX (SP), HL	MC <sub>1</sub>	T <sub>1</sub> T <sub>2</sub> T <sub>3</sub>	1st op-code Address	1st op-code	0	1	0	1	0	1	0
	MC <sub>2</sub>	T <sub>1</sub> T <sub>2</sub> T <sub>3</sub>	SP	DATA	0	1	0	1	1	1	1
	MC <sub>3</sub>	T <sub>1</sub> T <sub>2</sub> T <sub>3</sub>	SP+1	DATA	0	1	0	1	1	1	1
	MC <sub>4</sub>	T <sub>1</sub>	*	Z	1	1	1	1	1	1	1
	MC <sub>5</sub>	T <sub>1</sub> T <sub>2</sub> T <sub>3</sub>	SP+1	H	1	0	0	1	1	1	1
	MC <sub>6</sub>	T <sub>1</sub> T <sub>2</sub> T <sub>3</sub>	SP	L	1	0	0	1	1	1	1
EX (SP),X EX (SP),Y	MC <sub>1</sub>	T <sub>1</sub> T <sub>2</sub> T <sub>3</sub>	1st op-code Address	1st op-code	0	1	0	1	0	1	0
	MC <sub>2</sub>	T <sub>1</sub> T <sub>2</sub> T <sub>3</sub>	2nd op-code Address	2nd op-code	0	1	0	1	0	1	1
	MC <sub>3</sub>	T <sub>1</sub> T <sub>2</sub> T <sub>3</sub>	SP	DATA	0	1	0	1	1	1	1
	MC <sub>4</sub>	T <sub>1</sub> T <sub>2</sub> T <sub>3</sub>	SP+1	DATA	0	1	0	1	1	1	1
	MC <sub>5</sub>	T <sub>1</sub>	*	Z	1	1	1	1	1	1	1

\*2 DMA, REFRESH, or BUS RELEASE cannot be executed after this state. (Request is ignored)

to be continued

\*3 Interrupt request is not sampled.

Instruction	Machine Cycle	Status	ADDRESS	DATA	$\overline{RD}$	$\overline{WR}$	$\overline{MREQ}$	$\overline{IORO}$	$\overline{M1}$	$\overline{HALT}$	ST
EX (SP), IX EX (SP), IY	MC <sub>6</sub>	T <sub>1</sub> T <sub>2</sub> T <sub>3</sub>	SP+1	DH IYH	1	0	0	1	1	1	1
	MC <sub>7</sub>	T <sub>1</sub> T <sub>2</sub> T <sub>3</sub>	SP	DL IYL	1	0	0	1	1	1	1
HALT	MC <sub>1</sub>	T <sub>1</sub> T <sub>2</sub> T <sub>3</sub>	1st op-code Address	1st op-code	0	1	0	1	0	1	0
	—	—	Next op-code Address	Next op-code	0	1	0	1	0	0	0
IM 0 IM 1 IM 2	MC <sub>1</sub>	T <sub>1</sub> T <sub>2</sub> T <sub>3</sub>	1st op-code Address	1st op-code	0	1	0	1	0	1	0
	MC <sub>2</sub>	T <sub>1</sub> T <sub>2</sub> T <sub>3</sub>	2nd op-code Address	2nd op-code	0	1	0	1	0	1	1
INC g DEC g	MC <sub>1</sub>	T <sub>1</sub> T <sub>2</sub> T <sub>3</sub>	1st op-code Address	1st op-code	0	1	0	1	0	1	0
	MC <sub>2</sub>	T <sub>1</sub>	*	Z	1	1	1	1	1	1	1
INC HL DEC HL	MC <sub>1</sub>	T <sub>1</sub> T <sub>2</sub> T <sub>3</sub>	1st op-code Address	1st op-code	0	1	0	1	0	1	0
	MC <sub>2</sub>	T <sub>1</sub> T <sub>2</sub> T <sub>3</sub>	HL	DATA	0	1	0	1	1	1	1
	MC <sub>3</sub>	T <sub>1</sub>	*	Z	1	1	1	1	1	1	1
	MC <sub>4</sub>	T <sub>1</sub> T <sub>2</sub> T <sub>3</sub>	HL	DATA	1	0	0	1	1	1	1
INC (IX+d) INC (IY+d) DEC (IX+d) DEC (IY+d)	MC <sub>1</sub>	T <sub>1</sub> T <sub>2</sub> T <sub>3</sub>	1st op-code Address	1st op-code	0	1	0	1	0	1	0
	MC <sub>2</sub>	T <sub>1</sub> T <sub>2</sub> T <sub>3</sub>	2nd op-code Address	2nd op-code	0	1	0	1	0	1	1
	MC <sub>3</sub>	T <sub>1</sub> T <sub>2</sub> T <sub>3</sub>	1st operand Address	d	0	1	0	1	1	1	1
	MC <sub>4</sub> —MC <sub>5</sub>	T <sub>1</sub> T <sub>1</sub>	*	Z	1	1	1	1	1	1	1
	MC <sub>6</sub>	T <sub>1</sub> T <sub>2</sub> T <sub>3</sub>	IX+d IY+d	DATA	0	1	0	1	1	1	1
	MC <sub>7</sub>	T <sub>1</sub>	*	Z	1	1	1	1	1	1	1
	MC <sub>8</sub>	T <sub>1</sub> T <sub>2</sub> T <sub>3</sub>	IX+d IY+d	DATA	1	0	0	1	1	1	1
INC w DEC w	MC <sub>1</sub>	T <sub>1</sub> T <sub>2</sub> T <sub>3</sub>	1st op-code Address	1st op-code	0	1	0	1	0	1	0
	MC <sub>2</sub>	T <sub>1</sub>	*	Z	1	1	1	1	1	1	1
INC IX INC IY DEC IX DEC IY	MC <sub>1</sub>	T <sub>1</sub> T <sub>2</sub> T <sub>3</sub>	1st op-code Address	1st op-code	0	1	0	1	0	1	0
	MC <sub>2</sub>	T <sub>1</sub> T <sub>2</sub> T <sub>3</sub>	2nd op-code Address	2nd op-code	0	1	0	1	0	1	1
	MC <sub>3</sub>	T <sub>1</sub>	*	Z	1	1	1	1	1	1	1

Instruction	Machine Cycle	Status	ADDRESS	DATA	$\overline{RD}$	$\overline{WR}$	$\overline{MREQ}$	$\overline{IORQ}$	$\overline{MT}$	$\overline{HALT}$	ST
IN A (m)	MC <sub>1</sub>	T <sub>1</sub> T <sub>2</sub> T <sub>3</sub>	1st op-code Address	1st op-code	0	1	0	1	0	1	0
	MC <sub>2</sub>	T <sub>1</sub> T <sub>2</sub> T <sub>3</sub>	1st operand Address	m	0	1	0	1	1	1	1
	MC <sub>3</sub>	T <sub>1</sub> T <sub>2</sub> T <sub>3</sub>	m to A <sub>0</sub> -A <sub>7</sub> A to A <sub>8</sub> -A <sub>15</sub>	DATA	0	1	1	0	1	1	1
IN g (C)	MC <sub>1</sub>	T <sub>1</sub> T <sub>2</sub> T <sub>3</sub>	1st op-code Address	1st op-code	0	1	0	1	0	1	0
	MC <sub>2</sub>	T <sub>1</sub> T <sub>2</sub> T <sub>3</sub>	2nd op-code Address	2nd op-code	0	1	0	1	0	1	1
	MC <sub>3</sub>	T <sub>1</sub> T <sub>2</sub> T <sub>3</sub>	BC	DATA	0	1	1	0	1	1	1
IN g (m)~	MC <sub>1</sub>	T <sub>1</sub> T <sub>2</sub> T <sub>3</sub>	1st op-code Address	1st op-code	0	1	0	1	0	1	0
	MC <sub>2</sub>	T <sub>1</sub> T <sub>2</sub> T <sub>3</sub>	2nd op-code Address	2nd op-code	0	1	0	1	0	1	1
	MC <sub>3</sub>	T <sub>1</sub> T <sub>2</sub> T <sub>3</sub>	1st operand Address	m	0	1	0	1	1	1	1
	MC <sub>4</sub>	T <sub>1</sub> T <sub>2</sub> T <sub>3</sub>	m to A <sub>0</sub> -A <sub>7</sub> OOH to A <sub>8</sub> -A <sub>15</sub>	DATA	0	1	1	0	1	1	1
IN IN	MC <sub>1</sub>	T <sub>1</sub> T <sub>2</sub> T <sub>3</sub>	1st op-code Address	1st op-code	0	1	0	1	0	1	0
	MC <sub>2</sub>	T <sub>1</sub> T <sub>2</sub> T <sub>3</sub>	2nd op-code Address	2nd op-code	0	1	0	1	0	1	1
	MC <sub>3</sub>	T <sub>1</sub> T <sub>2</sub> T <sub>3</sub>	BC	DATA	0	1	1	0	1	1	1
	MC <sub>4</sub>	T <sub>1</sub> T <sub>2</sub> T <sub>3</sub>	HL	DATA	1	0	0	1	1	1	1
INR INDR (if Br ≠ 0)	MC <sub>1</sub>	T <sub>1</sub> T <sub>2</sub> T <sub>3</sub>	1st op-code Address	1st op-code	0	1	0	1	0	1	0
	MC <sub>2</sub>	T <sub>1</sub> T <sub>2</sub> T <sub>3</sub>	2nd op-code Address	2nd op-code	0	1	0	1	0	1	1
	MC <sub>3</sub>	T <sub>1</sub> T <sub>2</sub> T <sub>3</sub>	BC	DATA	0	1	1	0	1	1	1
	MC <sub>4</sub>	T <sub>1</sub> T <sub>2</sub> T <sub>3</sub>	HL	DATA	1	0	0	1	1	1	1
	MC <sub>5</sub> -MC <sub>6</sub>	TTT		Z	1	1	1	1	1	1	1
INR INDR (if Br = 0)	MC <sub>1</sub>	T <sub>1</sub> T <sub>2</sub> T <sub>3</sub>	1st op-code Address	1st op-code	0	1	0	1	0	1	0
	MC <sub>2</sub>	T <sub>1</sub> T <sub>2</sub> T <sub>3</sub>	2nd op-code Address	2nd op-code	0	1	0	1	0	1	1
	MC <sub>3</sub>	T <sub>1</sub> T <sub>2</sub> T <sub>3</sub>	BC	DATA	0	1	1	0	1	1	1
	MC <sub>4</sub>	T <sub>1</sub> T <sub>2</sub> T <sub>3</sub>	HL	DATA	1	0	0	1	1	1	1

to be continued

Instruction	Machine Cycle	States	ADDRESS	DATA	$\overline{RD}$	$\overline{WR}$	$\overline{MREQ}$	$\overline{IORQ}$	$\overline{M}_1$	$\overline{HALT}$	ST
JP mn	MC <sub>1</sub>	T <sub>1</sub> T <sub>2</sub> T <sub>3</sub>	1st op-code Address	1st op-code	0	1	0	1	0	1	0
	MC <sub>2</sub>	T <sub>1</sub> T <sub>2</sub> T <sub>3</sub>	1st operand Address	n	0	1	0	1	1	1	1
	MC <sub>3</sub>	T <sub>1</sub> T <sub>2</sub> T <sub>3</sub>	2nd operand Address	m	0	1	0	1	1	1	1
JP f,mn (f is false)	MC <sub>1</sub>	T <sub>1</sub> T <sub>2</sub> T <sub>3</sub>	1st op-code Address	1st op-code	0	1	0	1	0	1	0
	MC <sub>2</sub>	T <sub>1</sub> T <sub>2</sub> T <sub>3</sub>	1st operand Address	n	0	1	0	1	1	1	1
JP f,mn (f is true)	MC <sub>1</sub>	T <sub>1</sub> T <sub>2</sub> T <sub>3</sub>	1st op-code Address	1st op-code	0	1	0	1	0	1	0
	MC <sub>2</sub>	T <sub>1</sub> T <sub>2</sub> T <sub>3</sub>	1st operand Address	n	0	1	0	1	1	1	1
	MC <sub>3</sub>	T <sub>1</sub> T <sub>2</sub> T <sub>3</sub>	2nd operand Address	m	0	1	0	1	1	1	1
JP (HL)	MC <sub>1</sub>	T <sub>1</sub> T <sub>2</sub> T <sub>3</sub>	1st op-code Address	1st op-code	0	1	0	1	0	1	0
JP (D) JP (Y)	MC <sub>1</sub>	T <sub>1</sub> T <sub>2</sub> T <sub>3</sub>	1st op-code Address	1st op-code	0	1	0	1	0	1	0
	MC <sub>2</sub>	T <sub>1</sub> T <sub>2</sub> T <sub>3</sub>	2nd op-code Address	2nd op-code	0	1	0	1	0	1	1
JR j	MC <sub>1</sub>	T <sub>1</sub> T <sub>2</sub> T <sub>3</sub>	1st op-code Address	1st op-code	0	1	0	1	0	1	0
	MC <sub>2</sub>	T <sub>1</sub> T <sub>2</sub> T <sub>3</sub>	1st operand Address	j-2	0	1	0	1	1	1	1
	MC <sub>3</sub>	TiTi	*	Z	1	1	1	1	1	1	1
JR C <sub>j</sub> JR NC <sub>j</sub> JR Z <sub>j</sub> JR NZ <sub>j</sub> (f condition is false)	MC <sub>1</sub>	T <sub>1</sub> T <sub>2</sub> T <sub>3</sub>	1st op-code Address	1st op-code	0	1	0	1	0	1	0
	MC <sub>2</sub>	T <sub>1</sub> T <sub>2</sub> T <sub>3</sub>	1st operand Address	j-2	0	1	0	1	1	1	1
JR C <sub>j</sub> JR NC <sub>j</sub> JR Z <sub>j</sub> JR NZ <sub>j</sub> (f condition is true)	MC <sub>1</sub>	T <sub>1</sub> T <sub>2</sub> T <sub>3</sub>	1st op-code Address	1st op-code	0	1	0	1	0	1	0
	MC <sub>2</sub>	T <sub>1</sub> T <sub>2</sub> T <sub>3</sub>	1st operand Address	j-2	0	1	0	1	1	1	1
	~MC <sub>3</sub>	TiTi	*	Z	1	1	1	1	1	1	1
LD g,g'	MC <sub>1</sub>	T <sub>1</sub> T <sub>2</sub> T <sub>3</sub>	1st op-code Address	1st op-code	0	1	0	1	0	1	0
	MC <sub>2</sub>	Ti	*	Z	1	1	1	1	1	1	1
LD g,m	MC <sub>1</sub>	T <sub>1</sub> T <sub>2</sub> T <sub>3</sub>	1st op-code Address	1st op-code	0	1	0	1	0	1	0
	MC <sub>2</sub>	T <sub>1</sub> T <sub>2</sub> T <sub>3</sub>	1st operand Address	m	0	1	0	1	1	1	1

(to be continued)

Instruction	Machine Cycles	Status	ADDRESS	DATA	$\overline{RD}$	$\overline{WR}$	$\overline{MREQ}$	$\overline{IORG}$	$\overline{MI}$	$\overline{HALT}$	ST
LD g, (HL)	MC <sub>1</sub>	T <sub>1</sub> T <sub>2</sub> T <sub>3</sub>	1st op-code Address	1st op-code	0	1	0	1	0	1	0
	MC <sub>2</sub>	T <sub>1</sub> T <sub>2</sub> T <sub>3</sub>	HL	DATA	0	1	0	1	1	1	1
LD g, (X+d) LD g, (Y+d)	MC <sub>1</sub>	T <sub>1</sub> T <sub>2</sub> T <sub>3</sub>	1st op-code Address	1st op-code	0	1	0	1	0	1	0
	MC <sub>2</sub>	T <sub>1</sub> T <sub>2</sub> T <sub>3</sub>	2nd op-code Address	2nd op-code	0	1	0	1	0	1	1
	MC <sub>3</sub>	T <sub>1</sub> T <sub>2</sub> T <sub>3</sub>	1st operand Address	d	0	1	0	1	1	1	1
	MC <sub>4</sub> ~MC <sub>5</sub>	T <sub>1</sub> T <sub>1</sub>		Z	1	1	1	1	1	1	1
	MC <sub>6</sub>	T <sub>1</sub> T <sub>2</sub> T <sub>3</sub>	DX+d DY+d	DATA	0	1	0	1	1	1	1
LD (HL),g	MC <sub>1</sub>	T <sub>1</sub> T <sub>2</sub> T <sub>3</sub>	1st op-code Address	1st op-code	0	1	0	1	0	1	0
	MC <sub>2</sub>	T <sub>1</sub>		Z	1	1	1	1	1	1	1
	MC <sub>3</sub>	T <sub>1</sub> T <sub>2</sub> T <sub>3</sub>	HL	g	1	0	0	1	1	1	1
LD (X+d),g LD (Y+d),g	MC <sub>1</sub>	T <sub>1</sub> T <sub>2</sub> T <sub>3</sub>	1st op-code Address	1st op-code	0	1	0	1	0	1	0
	MC <sub>2</sub>	T <sub>1</sub> T <sub>2</sub> T <sub>3</sub>	2nd op-code Address	2nd op-code	0	1	0	1	0	1	1
	MC <sub>3</sub>	T <sub>1</sub> T <sub>2</sub> T <sub>3</sub>	1st operand Address	d	0	1	0	1	1	1	1
	MC <sub>4</sub> ~MC <sub>5</sub>	T <sub>1</sub> T <sub>1</sub> T <sub>1</sub>		Z	1	1	1	1	1	1	1
	MC <sub>7</sub>	T <sub>1</sub> T <sub>2</sub> T <sub>3</sub>	DX+d DY+d	g	1	0	0	1	1	1	1
LD (HL),m	MC <sub>1</sub>	T <sub>1</sub> T <sub>2</sub> T <sub>3</sub>	1st op-code Address	1st op-code	0	1	0	1	0	1	0
	MC <sub>2</sub>	T <sub>1</sub> T <sub>2</sub> T <sub>3</sub>	1st operand Address	m	0	1	0	1	1	1	1
	MC <sub>3</sub>	T <sub>1</sub> T <sub>2</sub> T <sub>3</sub>	HL	DATA	1	0	0	1	1	1	1
LD (X+d),m LD (Y+d),m	MC <sub>1</sub>	T <sub>1</sub> T <sub>2</sub> T <sub>3</sub>	1st op-code Address	1st op-code	0	1	0	1	0	1	0
	MC <sub>2</sub>	T <sub>1</sub> T <sub>2</sub> T <sub>3</sub>	2nd op-code Address	2nd op-code	0	1	0	1	0	1	1
	MC <sub>3</sub>	T <sub>1</sub> T <sub>2</sub> T <sub>3</sub>	1st operand Address	d	0	1	0	1	1	1	1
	MC <sub>4</sub>	T <sub>1</sub> T <sub>2</sub> T <sub>3</sub>	2nd operand Address	m	0	1	0	1	1	1	1
	MC <sub>5</sub>	T <sub>1</sub> T <sub>2</sub> T <sub>3</sub>	DX+d DY+d	DATA	1	0	0	1	1	1	1
LD A, (BC) LD A, (DE)	MC <sub>1</sub>	T <sub>1</sub> T <sub>2</sub> T <sub>3</sub>	1st op-code Address	1st op-code	0	1	0	1	0	1	0

to be continued

Instruction	Machine Cycle	Status	ADDRESS	DATA	RD	WR	MREQ	I/O $\overline{R}$ O	MI	HALT	ST
LD A, (BC) LD A, (DE)	MC <sub>2</sub>	T <sub>1</sub> T <sub>2</sub> T <sub>3</sub>	BC DE	DATA	0	1	0	1	1	1	1
LD A, (mn)	MC <sub>1</sub>	T <sub>1</sub> T <sub>2</sub> T <sub>3</sub>	1st op-code Address	1st op-code	0	1	0	1	0	1	0
	MC <sub>2</sub>	T <sub>1</sub> T <sub>2</sub> T <sub>3</sub>	1st operand Address	n	0	1	0	1	1	1	1
	MC <sub>3</sub>	T <sub>1</sub> T <sub>2</sub> T <sub>3</sub>	2nd operand Address	m	0	1	0	1	1	1	1
	MC <sub>4</sub>	T <sub>1</sub> T <sub>2</sub> T <sub>3</sub>	mn	DATA	0	1	0	1	1	1	1
LD (BC), A LD (DE), A	MC <sub>1</sub>	T <sub>1</sub> T <sub>2</sub> T <sub>3</sub>	1st op-code Address	1st op-code	0	1	0	1	0	1	0
	MC <sub>2</sub>	T <sub>i</sub>		Z	1	1	1	1	1	1	1
	MC <sub>3</sub>	T <sub>1</sub> T <sub>2</sub> T <sub>3</sub>	BC DE	A	1	0	0	1	1	1	1
LD (mn), A	MC <sub>1</sub>	T <sub>1</sub> T <sub>2</sub> T <sub>3</sub>	1st op-code Address	1st op-code	0	1	0	1	0	1	0
	MC <sub>2</sub>	T <sub>1</sub> T <sub>2</sub> T <sub>3</sub>	1st operand Address	n	0	1	0	1	1	1	1
	MC <sub>3</sub>	T <sub>1</sub> T <sub>2</sub> T <sub>3</sub>	2nd operand Address	m	0	1	0	1	1	1	1
	MC <sub>4</sub>	T <sub>i</sub>		Z	1	1	1	1	1	1	1
	MC <sub>5</sub>	T <sub>1</sub> T <sub>2</sub> T <sub>3</sub>	mn	A	1	0	0	1	1	1	1
LD A, I } *4 LD A, R } LD LA LD RA	MC <sub>1</sub>	T <sub>1</sub> T <sub>2</sub> T <sub>3</sub>	1st op-code Address	1st op-code	0	1	0	1	0	1	0
	MC <sub>2</sub>	T <sub>1</sub> T <sub>2</sub> T <sub>3</sub>	2nd op-code Address	2nd op-code	0	1	0	1	0	1	1
LD w, mn	MC <sub>1</sub>	T <sub>1</sub> T <sub>2</sub> T <sub>3</sub>	1st op-code Address	1st op-code	0	1	0	1	0	1	0
	MC <sub>2</sub>	T <sub>1</sub> T <sub>2</sub> T <sub>3</sub>	1st operand Address	n	0	1	0	1	1	1	1
	MC <sub>3</sub>	T <sub>1</sub> T <sub>2</sub> T <sub>3</sub>	2nd operand Address	m	0	1	0	1	1	1	1
LD IX, mn LD IY, mn	MC <sub>1</sub>	T <sub>1</sub> T <sub>2</sub> T <sub>3</sub>	1st op-code Address	1st op-code	0	1	0	1	0	1	0
	MC <sub>2</sub>	T <sub>1</sub> T <sub>2</sub> T <sub>3</sub>	2nd op-code Address	2nd op-code	0	1	0	1	0	1	1
	MC <sub>3</sub>	T <sub>1</sub> T <sub>2</sub> T <sub>3</sub>	1st operand Address	n	0	1	0	1	1	1	1
	MC <sub>4</sub>	T <sub>1</sub> T <sub>2</sub> T <sub>3</sub>	2nd operand Address	m	0	1	0	1	1	1	1
LD HL, (mn)	MC <sub>1</sub>	T <sub>1</sub> T <sub>2</sub> T <sub>3</sub>	1st op-code Address	1st op-code	0	1	0	1	0	1	0
	MC <sub>2</sub>	T <sub>1</sub> T <sub>2</sub> T <sub>3</sub>	1st operand Address	n	0	1	0	1	1	1	1

\*4 In the case of R1 and Z MASK, interrupt request is not sampled.

(to be continued)

Instruction	Machine Cycle	States	ADDRESS	DATA	RD	WR	MREQ	I/O	MT	HALT	ST
LD HL, (mn)	MC <sub>1</sub>	T <sub>1</sub> T <sub>2</sub> T <sub>3</sub>	2nd operand Address	m	0	1	0	1	1	1	1
	MC <sub>2</sub>	T <sub>1</sub> T <sub>2</sub> T <sub>3</sub>	mn	DATA	0	1	0	1	1	1	1
	MC <sub>3</sub>	T <sub>1</sub> T <sub>2</sub> T <sub>3</sub>	mn+1	DATA	0	1	0	1	1	1	1
LD ww, (mn)	MC <sub>1</sub>	T <sub>1</sub> T <sub>2</sub> T <sub>3</sub>	1st op-code Address	1st op-code	0	1	0	1	0	1	0
	MC <sub>2</sub>	T <sub>1</sub> T <sub>2</sub> T <sub>3</sub>	2nd op-code Address	2nd op-code	0	1	0	1	0	1	1
	MC <sub>3</sub>	T <sub>1</sub> T <sub>2</sub> T <sub>3</sub>	1st operand Address	n	0	1	0	1	1	1	1
	MC <sub>4</sub>	T <sub>1</sub> T <sub>2</sub> T <sub>3</sub>	2nd operand Address	m	0	1	0	1	1	1	1
	MC <sub>5</sub>	T <sub>1</sub> T <sub>2</sub> T <sub>3</sub>	mn	DATA	0	1	0	1	1	1	1
	MC <sub>6</sub>	T <sub>1</sub> T <sub>2</sub> T <sub>3</sub>	mn+1	DATA	0	1	0	1	1	1	1
LD IX, (mn) LD IY, (mn)	MC <sub>1</sub>	T <sub>1</sub> T <sub>2</sub> T <sub>3</sub>	1st op-code Address	1st op-code	0	1	0	1	0	1	0
	MC <sub>2</sub>	T <sub>1</sub> T <sub>2</sub> T <sub>3</sub>	2nd op-code Address	2nd op-code	0	1	0	1	0	1	1
	MC <sub>3</sub>	T <sub>1</sub> T <sub>2</sub> T <sub>3</sub>	1st operand Address	n	0	1	0	1	1	1	1
	MC <sub>4</sub>	T <sub>1</sub> T <sub>2</sub> T <sub>3</sub>	2nd operand Address	m	0	1	0	1	1	1	1
	MC <sub>5</sub>	T <sub>1</sub> T <sub>2</sub> T <sub>3</sub>	mn	DATA	0	1	0	1	1	1	1
	MC <sub>6</sub>	T <sub>1</sub> T <sub>2</sub> T <sub>3</sub>	mn+1	DATA	0	1	0	1	1	1	1
LD (mn), HL	MC <sub>1</sub>	T <sub>1</sub> T <sub>2</sub> T <sub>3</sub>	1st op-code Address	1st op-code	0	1	0	1	0	1	0
	MC <sub>2</sub>	T <sub>1</sub> T <sub>2</sub> T <sub>3</sub>	1st operand Address	n	0	1	0	1	1	1	1
	MC <sub>3</sub>	T <sub>1</sub> T <sub>2</sub> T <sub>3</sub>	2nd operand Address	m	0	1	0	1	1	1	1
	MC <sub>4</sub>	T <sub>1</sub>		Z	1	1	1	1	1	1	1
	MC <sub>5</sub>	T <sub>1</sub> T <sub>2</sub> T <sub>3</sub>	mn	L	1	0	0	1	1	1	1
	MC <sub>6</sub>	T <sub>1</sub> T <sub>2</sub> T <sub>3</sub>	mn+1	H	1	0	0	1	1	1	1

Instruction	Machine Cycle	Status	ADDRESS	DATA	RD	WR	MREQ	I/O	MT	HALT	ST
LD (mn),ww	MC <sub>1</sub>	T <sub>1</sub> T <sub>2</sub> T <sub>3</sub>	1st op-code Address	1st op-code	0	1	0	1	0	1	0
	MC <sub>2</sub>	T <sub>1</sub> T <sub>2</sub> T <sub>3</sub>	2nd op-code Address	2nd op-code	0	1	0	1	0	1	1
	MC <sub>3</sub>	T <sub>1</sub> T <sub>2</sub> T <sub>3</sub>	1st operand Address	n	0	1	0	1	1	1	1
	MC <sub>4</sub>	T <sub>1</sub> T <sub>2</sub> T <sub>3</sub>	2nd operand Address	m	0	1	0	1	1	1	1
	MC <sub>5</sub>	T <sub>1</sub>		Z	1	1	1	1	1	1	1
	MC <sub>6</sub>	T <sub>1</sub> T <sub>2</sub> T <sub>3</sub>	mn	wwL	1	0	0	1	1	1	1
	MC <sub>7</sub>	T <sub>1</sub> T <sub>2</sub> T <sub>3</sub>	mn+1	wwH	1	0	0	1	1	1	1
LD (mn),DX LD (mn),Y	MC <sub>1</sub>	T <sub>1</sub> T <sub>2</sub> T <sub>3</sub>	1st op-code Address	1st op-code	0	1	0	1	0	1	0
	MC <sub>2</sub>	T <sub>1</sub> T <sub>2</sub> T <sub>3</sub>	2nd op-code Address	2nd op-code	0	1	0	1	0	1	1
	MC <sub>3</sub>	T <sub>1</sub> T <sub>2</sub> T <sub>3</sub>	1st operand Address	n	0	1	0	1	1	1	1
	MC <sub>4</sub>	T <sub>1</sub> T <sub>2</sub> T <sub>3</sub>	2nd operand Address	m	0	1	0	1	1	1	1
	MC <sub>5</sub>	T <sub>1</sub>		Z	1	1	1	1	1	1	1
	MC <sub>6</sub>	T <sub>1</sub> T <sub>2</sub> T <sub>3</sub>	mn	DXL YH	1	0	0	1	1	1	1
	MC <sub>7</sub>	T <sub>1</sub> T <sub>2</sub> T <sub>3</sub>	mn+1	DXH YH	1	0	0	1	1	1	1
LD SP, HL	MC <sub>1</sub>	T <sub>1</sub> T <sub>2</sub> T <sub>3</sub>	1st op-code Address	1st op-code	0	1	0	1	0	1	0
	MC <sub>2</sub>	T <sub>1</sub>		Z	1	1	1	1	1	1	1
LD SP,DX LD SP,Y	MC <sub>1</sub>	T <sub>1</sub> T <sub>2</sub> T <sub>3</sub>	1st op-code Address	1st op-code	0	1	0	1	0	1	0
	MC <sub>2</sub>	T <sub>1</sub> T <sub>2</sub> T <sub>3</sub>	2nd op-code Address	2nd op-code	0	1	0	1	0	1	1
	MC <sub>3</sub>	T <sub>1</sub>		Z	1	1	1	1	1	1	1
LDI LDD	MC <sub>1</sub>	T <sub>1</sub> T <sub>2</sub> T <sub>3</sub>	1st op-code Address	1st op-code	0	1	0	1	0	1	0
	MC <sub>2</sub>	T <sub>1</sub> T <sub>2</sub> T <sub>3</sub>	2nd op-code Address	2nd op-code	0	1	0	1	0	1	1
	MC <sub>3</sub>	T <sub>1</sub> T <sub>2</sub> T <sub>3</sub>	HL	DATA	0	1	0	1	1	1	1
	MC <sub>4</sub>	T <sub>1</sub> T <sub>2</sub> T <sub>3</sub>	DE	DATA	1	0	0	1	1	1	1

to be continued

Instruction	Machine Cycle	Status	ADDRESS	DATA	$\overline{RD}$	$\overline{WR}$	$\overline{MREQ}$	$\overline{IORQ}$	$\overline{MT}$	$\overline{HALT}$	ST
LDR LDDR (if $BC_n \neq 0$ )	MC <sub>1</sub>	T <sub>1</sub> T <sub>2</sub> T <sub>3</sub>	1st op-code Address	1st op-code	0	1	0	1	0	1	0
	MC <sub>2</sub>	T <sub>1</sub> T <sub>2</sub> T <sub>3</sub>	2nd op-code Address	2nd op-code	0	1	0	1	0	1	1
	MC <sub>3</sub>	T <sub>1</sub> T <sub>2</sub> T <sub>3</sub>	HL	DATA	0	1	0	1	1	1	1
	MC <sub>4</sub>	T <sub>1</sub> T <sub>2</sub> T <sub>3</sub>	DE	DATA	1	0	0	1	1	1	1
	MC <sub>5</sub> -MC <sub>6</sub>	T <sub>1</sub> T <sub>1</sub>		Z	1	1	1	1	1	1	1
LDR LDDR (if $BC_n = 0$ )	MC <sub>1</sub>	T <sub>1</sub> T <sub>2</sub> T <sub>3</sub>	1st op-code Address	1st op-code	0	1	0	1	0	1	0
	MC <sub>2</sub>	T <sub>1</sub> T <sub>2</sub> T <sub>3</sub>	2nd op-code Address	2nd op-code	0	1	0	1	0	1	1
	MC <sub>3</sub>	T <sub>1</sub> T <sub>2</sub> T <sub>3</sub>	HL	DATA	0	1	0	1	1	1	1
	MC <sub>4</sub>	T <sub>1</sub> T <sub>2</sub> T <sub>3</sub>	DE	DATA	1	0	0	1	1	1	1
MLT wv**	MC <sub>1</sub>	T <sub>1</sub> T <sub>2</sub> T <sub>3</sub>	1st op-code Address	1st op-code	0	1	0	1	0	1	0
	MC <sub>2</sub>	T <sub>1</sub> T <sub>2</sub> T <sub>3</sub>	2nd op-code Address	2nd op-code	0	1	0	1	0	1	1
	MC <sub>3</sub> -MC <sub>4</sub>	T <sub>1</sub> T <sub>1</sub> T <sub>1</sub> T <sub>1</sub> T <sub>1</sub> T <sub>1</sub> T <sub>1</sub> T <sub>1</sub> T <sub>1</sub>		Z	1	1	1	1	1	1	1
NEG	MC <sub>1</sub>	T <sub>1</sub> T <sub>2</sub> T <sub>3</sub>	1st op-code Address	1st op-code	0	1	0	1	0	1	0
	MC <sub>2</sub>	T <sub>1</sub> T <sub>2</sub> T <sub>3</sub>	2nd op-code Address	2nd op-code	0	1	0	1	0	1	1
NOP	MC <sub>1</sub>	T <sub>1</sub> T <sub>2</sub> T <sub>3</sub>	1st op-code Address	1st op-code	0	1	0	1	0	1	0
OUT (m),A	MC <sub>1</sub>	T <sub>1</sub> T <sub>2</sub> T <sub>3</sub>	1st op-code Address	1st op-code	0	1	0	1	0	1	0
	MC <sub>2</sub>	T <sub>1</sub> T <sub>2</sub> T <sub>3</sub>	1st operand Address	m	0	1	0	1	1	1	1
	MC <sub>3</sub>	T <sub>1</sub>		Z	1	1	1	1	1	1	1
	MC <sub>4</sub>	T <sub>1</sub> T <sub>2</sub> T <sub>3</sub>	m to A <sub>0</sub> -A <sub>7</sub> A to A <sub>8</sub> -A <sub>15</sub>	A	1	0	1	0	1	1	1

(to be continued)

Instruction	Machine Cycle	Status	ADDRESS	DATA	$\overline{RD}$	$\overline{WR}$	$\overline{MREQ}$	$\overline{IORO}$	$\overline{MI}$	$\overline{HALT}$	ST
OUT (C),g	MC <sub>1</sub>	T <sub>1</sub> T <sub>2</sub> T <sub>3</sub>	1st op-code Address	1st op-code	0	1	0	1	0	1	0
	MC <sub>2</sub>	T <sub>1</sub> T <sub>2</sub> T <sub>3</sub>	2nd op-code Address	2nd op-code	0	1	0	1	0	1	1
	MC <sub>3</sub>	T <sub>1</sub>	.	Z	1	1	1	1	1	1	1
	MC <sub>4</sub>	T <sub>1</sub> T <sub>2</sub> T <sub>3</sub>	BC	g	1	0	1	0	1	1	1
OUTO (m),g**	MC <sub>1</sub>	T <sub>1</sub> T <sub>2</sub> T <sub>3</sub>	1st op-code Address	1st op-code	0	1	0	1	0	1	0
	MC <sub>2</sub>	T <sub>1</sub> T <sub>2</sub> T <sub>3</sub>	2nd op-code Address	2nd op-code	0	1	0	1	0	1	1
	MC <sub>3</sub>	T <sub>1</sub> T <sub>2</sub> T <sub>3</sub>	1st operand Address	m	0	1	0	1	1	1	1
	MC <sub>4</sub>	T <sub>1</sub>	.	Z	1	1	1	1	1	1	1
	MC <sub>5</sub>	T <sub>1</sub> T <sub>2</sub> T <sub>3</sub>	m to A <sub>0</sub> -A <sub>7</sub> OOH to A <sub>1</sub> -A <sub>15</sub>	g	1	0	1	0	1	1	1
OTIM** OTDM**	MC <sub>1</sub>	T <sub>1</sub> T <sub>2</sub> T <sub>3</sub>	1st op-code Address	1st op-code	0	1	0	1	0	1	0
	MC <sub>2</sub>	T <sub>1</sub> T <sub>2</sub> T <sub>3</sub>	2nd op-code Address	2nd op-code	0	1	0	1	0	1	1
	MC <sub>3</sub>	T <sub>1</sub>	.	Z	1	1	1	1	1	1	1
	MC <sub>4</sub>	T <sub>1</sub> T <sub>2</sub> T <sub>3</sub>	HL	DATA	0	1	0	1	1	1	1
	MC <sub>5</sub>	T <sub>1</sub> T <sub>2</sub> T <sub>3</sub>	C to A <sub>0</sub> -A <sub>7</sub> OOH to A <sub>1</sub> -A <sub>15</sub>	DATA	1	0	1	0	1	1	1
	MC <sub>6</sub>	T <sub>1</sub>	.	Z	1	1	1	1	1	1	1
OTIMR** OTDMR** (If Br ≠ 0)	MC <sub>1</sub>	T <sub>1</sub> T <sub>2</sub> T <sub>3</sub>	1st op-code Address	1st op-code	0	1	0	1	0	1	0
	MC <sub>2</sub>	T <sub>1</sub> T <sub>2</sub> T <sub>3</sub>	2nd op-code Address	2nd op-code	0	1	0	1	0	1	1
	MC <sub>3</sub>	T <sub>1</sub>	.	Z	1	1	1	1	1	1	1
	MC <sub>4</sub>	T <sub>1</sub> T <sub>2</sub> T <sub>3</sub>	HL	DATA	0	1	0	1	1	1	1
	MC <sub>5</sub>	T <sub>1</sub> T <sub>2</sub> T <sub>3</sub>	C to A <sub>0</sub> -A <sub>7</sub> OOH to A <sub>1</sub> -A <sub>15</sub>	DATA	1	0	1	0	1	1	1
	MC <sub>6</sub> -MC <sub>1</sub>	T <sub>1</sub> T <sub>1</sub> T <sub>1</sub>	.	Z	1	1	1	1	1	1	1

to be continued

Instruction	Machine Code	Status	ADDRESS	DATA	RD	WR	MREQ	IORQ	MT	HALT	ST
OTIMR** OTDMR** (If Br=0)	MC <sub>1</sub>	T <sub>1</sub> T <sub>2</sub> T <sub>3</sub>	1st op-code Address	1st op-code	0	1	0	1	0	1	0
	MC <sub>2</sub>	T <sub>1</sub> T <sub>2</sub> T <sub>3</sub>	2nd op-code Address	2nd op-code	0	1	0	1	0	1	1
	MC <sub>3</sub>	T <sub>i</sub>	.	Z	1	1	1	1	1	1	1
	MC <sub>4</sub>	T <sub>1</sub> T <sub>2</sub> T <sub>3</sub>	HL	DATA	0	1	0	1	1	1	1
	MC <sub>5</sub>	T <sub>1</sub> T <sub>2</sub> T <sub>3</sub>	C to A <sub>0</sub> -A <sub>7</sub> OOH to A <sub>8</sub> -A <sub>15</sub>	DATA	1	0	1	0	1	1	1
	MC <sub>6</sub>	T <sub>i</sub>	.	Z	1	1	1	1	1	1	1
OUTI OUTD	MC <sub>1</sub>	T <sub>1</sub> T <sub>2</sub> T <sub>3</sub>	1st op-code Address	1st op-code	0	1	0	1	0	1	0
	MC <sub>2</sub>	T <sub>1</sub> T <sub>2</sub> T <sub>3</sub>	2nd op-code Address	2nd op-code	0	1	0	1	0	1	1
	MC <sub>3</sub>	T <sub>1</sub> T <sub>2</sub> T <sub>3</sub>	HL	DATA	0	1	0	1	1	1	1
	MC <sub>4</sub>	T <sub>1</sub> T <sub>2</sub> T <sub>3</sub>	BC	DATA	1	0	1	0	1	1	1
OTIR OTDR (If Br≠0)	MC <sub>1</sub>	T <sub>1</sub> T <sub>2</sub> T <sub>3</sub>	1st op-code Address	1st op-code	0	1	0	1	0	1	0
	MC <sub>2</sub>	T <sub>1</sub> T <sub>2</sub> T <sub>3</sub>	2nd op-code Address	2nd op-code	0	1	0	1	0	1	1
	MC <sub>3</sub>	T <sub>1</sub> T <sub>2</sub> T <sub>3</sub>	HL	DATA	0	1	0	1	1	1	1
	MC <sub>4</sub>	T <sub>1</sub> T <sub>2</sub> T <sub>3</sub>	BC	DATA	1	0	1	0	1	1	1
	MC <sub>5</sub> -MC <sub>6</sub>	T <sub>i</sub> T <sub>i</sub>	.	Z	1	1	1	1	1	1	1
OTIR OTDR (If Br=0)	MC <sub>1</sub>	T <sub>1</sub> T <sub>2</sub> T <sub>3</sub>	1st op-code Address	1st op-code	0	1	0	1	0	1	0
	MC <sub>2</sub>	T <sub>1</sub> T <sub>2</sub> T <sub>3</sub>	2nd op-code Address	2nd op-code	0	1	0	1	0	1	1
	MC <sub>3</sub>	T <sub>1</sub> T <sub>2</sub> T <sub>3</sub>	HL	DATA	0	1	0	1	1	1	1
	MC <sub>4</sub>	T <sub>1</sub> T <sub>2</sub> T <sub>3</sub>	BC	DATA	1	0	1	0	1	1	1
POP zz	MC <sub>1</sub>	T <sub>1</sub> T <sub>2</sub> T <sub>3</sub>	1st op-code Address	1st op-code	0	1	0	1	0	1	0
	MC <sub>2</sub>	T <sub>1</sub> T <sub>2</sub> T <sub>3</sub>	SP	DATA	0	1	0	1	1	1	1
	MC <sub>3</sub>	T <sub>1</sub> T <sub>2</sub> T <sub>3</sub>	SP+1	DATA	0	1	0	1	1	1	1
POP IX POP IY	MC <sub>1</sub>	T <sub>1</sub> T <sub>2</sub> T <sub>3</sub>	1st op-code Address	1st op-code	0	1	0	1	0	1	0

(to be continued)

Instruction	Machine Cycle	Status	ADDRESS	DATA	$\overline{RD}$	$\overline{WR}$	$\overline{MREQ}$	$\overline{IORO}$	$\overline{MT}$	$\overline{HALT}$	ST
POP IX POP IY	MC <sub>2</sub>	T <sub>1</sub> T <sub>2</sub> T <sub>3</sub>	2nd op-code Address	2nd op-code	0	1	0	1	0	1	1
	MC <sub>3</sub>	T <sub>1</sub> T <sub>2</sub> T <sub>3</sub>	SP	DATA	0	1	0	1	1	1	1
	MC <sub>4</sub>	T <sub>1</sub> T <sub>2</sub> T <sub>3</sub>	SP+1	DATA	0	1	0	1	1	1	1
PUSH zz	MC <sub>1</sub>	T <sub>1</sub> T <sub>2</sub> T <sub>3</sub>	1st op-code Address	1st op-code	0	1	0	1	0	1	0
	MC <sub>2</sub> -MC <sub>3</sub>	T <sub>1</sub> T <sub>1</sub>		Z	1	1	1	1	1	1	1
	MC <sub>3</sub>	T <sub>1</sub> T <sub>2</sub> T <sub>3</sub>	SP-1	zzH	1	0	0	1	1	1	1
	MC <sub>4</sub>	T <sub>1</sub> T <sub>2</sub> T <sub>3</sub>	SP-2	zzL	1	0	0	1	1	1	1
PUSH IX PUSH IY	MC <sub>1</sub>	T <sub>1</sub> T <sub>2</sub> T <sub>3</sub>	1st op-code Address	1st op-code	0	1	0	1	0	1	0
	MC <sub>2</sub>	T <sub>1</sub> T <sub>2</sub> T <sub>3</sub>	2nd op-code Address	2nd op-code	0	1	0	1	0	1	1
	MC <sub>3</sub> -MC <sub>4</sub>	T <sub>1</sub> T <sub>1</sub>		Z	1	1	1	1	1	1	1
	MC <sub>4</sub>	T <sub>1</sub> T <sub>2</sub> T <sub>3</sub>	SP-1	DXH IYH	1	0	0	1	1	1	1
	MC <sub>5</sub>	T <sub>1</sub> T <sub>2</sub> T <sub>3</sub>	SP-2	DXL IYL	1	0	0	1	1	1	1
RET	MC <sub>1</sub>	T <sub>1</sub> T <sub>2</sub> T <sub>3</sub>	1st op-code Address	1st op-code	0	1	0	1	0	1	0
	MC <sub>2</sub>	T <sub>1</sub> T <sub>2</sub> T <sub>3</sub>	SP	DATA	0	1	0	1	1	1	1
	MC <sub>3</sub>	T <sub>1</sub> T <sub>2</sub> T <sub>3</sub>	SP+1	DATA	0	1	0	1	1	1	1
RET f (if condition is false)	MC <sub>1</sub>	T <sub>1</sub> T <sub>2</sub> T <sub>3</sub>	1st op-code Address	1st op-code	0	1	0	1	0	1	0
	MC <sub>2</sub> -MC <sub>3</sub>	T <sub>1</sub> T <sub>1</sub>		Z	1	1	1	1	1	1	1
RET f (if condition is true)	MC <sub>1</sub>	T <sub>1</sub> T <sub>2</sub> T <sub>3</sub>	1st op-code Address	1st op-code	0	1	0	1	0	1	0
	MC <sub>2</sub>	T <sub>1</sub>		Z	1	1	1	1	1	1	1
	MC <sub>3</sub>	T <sub>1</sub> T <sub>2</sub> T <sub>3</sub>	SP	DATA	0	1	0	1	1	1	1
	MC <sub>4</sub>	T <sub>1</sub> T <sub>2</sub> T <sub>3</sub>	SP+1	DATA	0	1	0	1	1	1	1
RETI (R0, R1) RETN	MC <sub>1</sub>	T <sub>1</sub> T <sub>2</sub> T <sub>3</sub>	1st op-code Address	1st op-code	0	1	0	1	0	1	0
	MC <sub>2</sub>	T <sub>1</sub> T <sub>2</sub> T <sub>3</sub>	2nd op-code Address	2nd op-code	0	1	0	1	0	1	1
	MC <sub>3</sub>	T <sub>1</sub> T <sub>2</sub> T <sub>3</sub>	SP	DATA	0	1	0	1	1	1	1
	MC <sub>4</sub>	T <sub>1</sub> T <sub>2</sub> T <sub>3</sub>	SP+1	DATA	0	1	0	1	1	1	1

(to be continued)

Instruction	Machine Cycle	States	ADDRESS	DATA	$\overline{RD}$	$\overline{WR}$	$\overline{MREQ}$	$\overline{IORQ}$	$\overline{MI}$	HALT	ST	
RETI (Z)	MC <sub>1</sub>	T <sub>1</sub> T <sub>2</sub> T <sub>3</sub>	1st op-code Address	1st op-code	0	1	0	1	0 <sup>*5</sup> 1	1	0	
	MC <sub>2</sub>	T <sub>1</sub> T <sub>2</sub> T <sub>3</sub>	2nd op-code Address	2nd op-code	0	1	0	1	0 <sup>*5</sup> 1	1	1	
	MC <sub>3</sub> ~MC <sub>3</sub>	T <sub>1</sub> T <sub>1</sub> T <sub>1</sub>	.	Z	1	1	1	1	1 <sup>*5</sup> 1	1	1	
	MC <sub>4</sub>	T <sub>1</sub> T <sub>2</sub> T <sub>3</sub>	1st op-code Address	1st op-code	0	1	0	1	0 <sup>*5</sup> 0	1	1	
	MC <sub>5</sub>	T <sub>1</sub>	.	Z	1	1	1	1	1 <sup>*5</sup> 1	1	1	
	MC <sub>6</sub>	T <sub>1</sub> T <sub>2</sub> T <sub>3</sub>	2nd op-code Address	2nd op-code	0	1	0	1	0 <sup>*5</sup> 0	1	1	
	MC <sub>7</sub>	T <sub>1</sub> T <sub>2</sub> T <sub>3</sub>	SP	data	0	1	0	1	1 <sup>*5</sup> 1	1	1	
	MC <sub>8</sub>	T <sub>1</sub> T <sub>2</sub> T <sub>3</sub>	SP + 1	data	0	1	0	1	1 <sup>*5</sup> 1	1	1	
	RLCA RLA RRCA RRA	MC <sub>1</sub>	T <sub>1</sub> T <sub>2</sub> T <sub>3</sub>	1st op-code Address	1st op-code	0	1	0	1	0	1	0
	RLC g RL g RRC g RR g SLA g SRA g SRL g	MC <sub>1</sub>	T <sub>1</sub> T <sub>2</sub> T <sub>3</sub>	1st op-code Address	1st op-code	0	1	0	1	0	1	0
MC <sub>2</sub>		T <sub>1</sub> T <sub>2</sub> T <sub>3</sub>	2nd op-code Address	2nd op-code	0	1	0	1	0	1	1	
MC <sub>3</sub>		T <sub>1</sub>	.	Z	1	1	1	1	1	1	1	
RLC (HL) RL (HL) RRC (HL) RR (HL) SLA (HL) SRA (HL) SRL (HL)	MC <sub>1</sub>	T <sub>1</sub> T <sub>2</sub> T <sub>3</sub>	1st op-code Address	1st op-code	0	1	0	1	0	1	0	
	MC <sub>2</sub>	T <sub>1</sub> T <sub>2</sub> T <sub>3</sub>	2nd op-code Address	2nd op-code	0	1	0	1	0	1	1	
	MC <sub>3</sub>	T <sub>1</sub> T <sub>2</sub> T <sub>3</sub>	HL	DATA	0	1	0	1	1	1	1	
	MC <sub>4</sub>	T <sub>1</sub>	.	Z	1	1	1	1	1	1	1	
	MC <sub>5</sub>	T <sub>1</sub> T <sub>2</sub> T <sub>3</sub>	HL	DATA	1	0	0	1	1	1	1	

\*5 The upper and lower data show the state of LIR when  $\overline{IOC} = 1$  and  $\overline{IOC} = 0$  respectively.

(to be continued)

Instruction	Machine Cycle	States	ADDRESS	DATA	$\overline{RD}$	$\overline{WR}$	$\overline{MREQ}$	$\overline{IORO}$	$\overline{M1}$	$\overline{HALT}$	ST
RLC (X+d) RLC (Y+d) RL (X+d) RL (Y+d) RRC (X+d) RRC (Y+d) RR (X+d) RR (Y+d) SLA (X+d) SLA (Y+d) SRA (X+d) SRA (Y+d) SRL (X+d) SRL (Y+d)	MC <sub>1</sub>	T <sub>1</sub> T <sub>2</sub> T <sub>3</sub>	1st op-code Address	1st op-code	0	1	0	0	0	1	0
	MC <sub>2</sub>	T <sub>1</sub> T <sub>2</sub> T <sub>3</sub>	2nd op-code Address	2nd op-code	0	1	0	1	0	1	1
	MC <sub>3</sub>	T <sub>1</sub> T <sub>2</sub> T <sub>3</sub>	1st operand Address	d	0	1	0	1	1	1	1
	MC <sub>4</sub>	T <sub>1</sub> T <sub>2</sub> T <sub>3</sub>	3rd op-code Address	3rd op-code	0	1	0	1	0	1	1
	MC <sub>5</sub>	T <sub>1</sub> T <sub>2</sub> T <sub>3</sub>	IX+d IY+d	DATA	0	1	0	1	1	1	1
	MC <sub>6</sub>	T <sub>1</sub>		Z	1	1	1	1	1	1	1
	MC <sub>7</sub>	T <sub>1</sub> T <sub>2</sub> T <sub>3</sub>	IX+d IY+d	DATA	1	0	0	1	1	1	1
	RLD RRD	MC <sub>1</sub>	T <sub>1</sub> T <sub>2</sub> T <sub>3</sub>	1st op-code Address	1st op-code	0	1	0	1	0	1
MC <sub>2</sub>		T <sub>1</sub> T <sub>2</sub> T <sub>3</sub>	2nd op-code Address	2nd op-code	0	1	0	1	0	1	1
MC <sub>3</sub>		T <sub>1</sub> T <sub>2</sub> T <sub>3</sub>	HL	DATA	0	1	0	1	1	1	1
MC <sub>4</sub> -MC <sub>7</sub>		T <sub>1</sub> T <sub>2</sub> T <sub>3</sub>		Z	1	1	1	1	1	1	1
MC <sub>6</sub>		T <sub>1</sub> T <sub>2</sub> T <sub>3</sub>	HL	DATA	1	0	0	1	1	1	1
RST v	MC <sub>1</sub>	T <sub>1</sub> T <sub>2</sub> T <sub>3</sub>	1st op-code Address	1st op-code	0	1	0	1	0	1	0
	MC <sub>2</sub> -MC <sub>3</sub>	T <sub>1</sub> T <sub>2</sub> T <sub>3</sub>		Z	1	1	1	1	1	1	1
	MC <sub>4</sub>	T <sub>1</sub> T <sub>2</sub> T <sub>3</sub>	SP-1	PCH	1	0	0	1	1	1	1
	MC <sub>5</sub>	T <sub>1</sub> T <sub>2</sub> T <sub>3</sub>	SP-2	PCL	1	0	0	1	1	1	1
SCF	MC <sub>1</sub>	T <sub>1</sub> T <sub>2</sub> T <sub>3</sub>	1st op-code Address	1st op-code	0	1	0	1	0	1	0
SET b.g RES b.g	MC <sub>1</sub>	T <sub>1</sub> T <sub>2</sub> T <sub>3</sub>	1st op-code Address	1st op-code	0	1	0	1	0	1	0
	MC <sub>2</sub>	T <sub>1</sub> T <sub>2</sub> T <sub>3</sub>	2nd op-code Address	2nd op-code	0	1	0	1	0	1	1
	MC <sub>3</sub>	T <sub>1</sub>		Z	1	1	1	1	1	1	1
SET b. (HL) RES b. (HL)	MC <sub>1</sub>	T <sub>1</sub> T <sub>2</sub> T <sub>3</sub>	1st op-code Address	1st op-code	0	1	0	1	0	1	0
	MC <sub>2</sub>	T <sub>1</sub> T <sub>2</sub> T <sub>3</sub>	2nd op-code Address	2nd op-code	0	1	0	1	0	1	1
	MC <sub>3</sub>	T <sub>1</sub> T <sub>2</sub> T <sub>3</sub>	HL	DATA	0	1	0	1	1	1	1
	MC <sub>4</sub>	T <sub>1</sub>		Z	1	1	1	1	1	1	1
	MC <sub>5</sub>	T <sub>1</sub> T <sub>2</sub> T <sub>3</sub>	HL	DATA	1	0	0	1	1	1	1

(to be continued)

Instruction	Machine Cycle	States	ADDRESS	DATA	$\overline{RD}$	$\overline{WR}$	$\overline{MREQ}$	$\overline{IORO}$	$\overline{M1}$	$\overline{HALT}$	ST
SET b, BX+d SET b, (Y+d) RES b, BX+d RES b, (Y+d)	MC <sub>1</sub>	T <sub>1</sub> T <sub>2</sub> T <sub>3</sub>	1st op-code Address	1st op-code	0	1	0	1	0	1	0
	MC <sub>2</sub>	T <sub>1</sub> T <sub>2</sub> T <sub>3</sub>	2nd op-code Address	2nd op-code	0	1	0	1	0	1	1
	MC <sub>3</sub>	T <sub>1</sub> T <sub>2</sub> T <sub>3</sub>	1st operand Address	d	0	1	0	1	1	1	1
	MC <sub>4</sub>	T <sub>1</sub> T <sub>2</sub> T <sub>3</sub>	3rd op-code Address	3rd op-code	0	1	0	1	0	1	1
	MC <sub>5</sub>	T <sub>1</sub> T <sub>2</sub> T <sub>3</sub>	IX+d IY+d	DATA	0	1	0	1	1	1	1
	MC <sub>6</sub>	T <sub>1</sub>		Z	1	1	1	1	1	1	1
	MC <sub>7</sub>	T <sub>1</sub> T <sub>2</sub> T <sub>3</sub>	IX+d IY+d	DATA	1	0	0	1	1	1	1
SLP**	MC <sub>1</sub>	T <sub>1</sub> T <sub>2</sub> T <sub>3</sub>	1st op-code Address	1st op-code	0	1	0	1	0	1	0
	MC <sub>2</sub>	T <sub>1</sub> T <sub>2</sub> T <sub>3</sub>	2nd op-code Address	2nd op-code	0	1	0	1	0	1	1
	-	-	7FFFFH	Z	1	1	1	1	1	0	1
TSTIO m**	MC <sub>1</sub>	T <sub>1</sub> T <sub>2</sub> T <sub>3</sub>	1st op-code Address	1st op-code	0	1	0	1	0	1	0
	MC <sub>2</sub>	T <sub>1</sub> T <sub>2</sub> T <sub>3</sub>	2nd op-code Address	2nd op-code	0	1	0	1	0	1	1
	MC <sub>3</sub>	T <sub>1</sub> T <sub>2</sub> T <sub>3</sub>	1st operand Address	m	0	1	0	1	1	1	1
	MC <sub>4</sub>	T <sub>1</sub> T <sub>2</sub> T <sub>3</sub>	C to A <sub>0</sub> -A <sub>7</sub> OOH to A <sub>8</sub> -A <sub>15</sub>	DATA	0	1	1	0	1	1	1
TST g**	MC <sub>1</sub>	T <sub>1</sub> T <sub>2</sub> T <sub>3</sub>	1st op-code Address	1st op-code	0	1	0	1	0	1	0
	MC <sub>2</sub>	T <sub>1</sub> T <sub>2</sub> T <sub>3</sub>	2nd op-code Address	2nd op-code	0	1	0	1	0	1	1
	MC <sub>3</sub>	T <sub>1</sub>		Z	1	1	1	1	1	1	1
TST m**	MC <sub>1</sub>	T <sub>1</sub> T <sub>2</sub> T <sub>3</sub>	1st op-code Address	1st op-code	0	1	0	1	0	1	0
	MC <sub>2</sub>	T <sub>1</sub> T <sub>2</sub> T <sub>3</sub>	2nd op-code Address	2nd op-code	0	1	0	1	0	1	1
	MC <sub>3</sub>	T <sub>1</sub> T <sub>2</sub> T <sub>3</sub>	1st operand Address	m	0	1	0	1	1	1	1
TST (HU)**	MC <sub>1</sub>	T <sub>1</sub> T <sub>2</sub> T <sub>3</sub>	1st op-code Address	1st op-code	0	1	0	1	0	1	0
	MC <sub>2</sub>	T <sub>1</sub> T <sub>2</sub> T <sub>3</sub>	2nd op-code Address	2nd op-code	0	1	0	1	0	1	1
	MC <sub>3</sub>	T <sub>1</sub>		Z	1	1	1	1	1	1	1
	MC <sub>4</sub>	T <sub>1</sub> T <sub>2</sub> T <sub>3</sub>	HL	DATA	0	1	0	1	1	1	1

## INTERRUPT

Instruction	Machine Cycle	States	ADDRESS	DATA	$\overline{RD}$	$\overline{WR}$	$\overline{MREQ}$	$\overline{IORQ}$	$\overline{MT}$	$\overline{HALT}$	ST
$\overline{NM}$	MC <sub>1</sub>	T <sub>1</sub> T <sub>2</sub> T <sub>3</sub>	Next op-code Address (PC)		0	1	0	1	0	1	0
	MC <sub>2</sub> ~MC <sub>3</sub>	T <sub>1</sub> T <sub>1</sub>	.	Z	1	1	1	1	1	1	1
	MC <sub>4</sub>	T <sub>1</sub> T <sub>2</sub> T <sub>3</sub>	SP-1	PCH	1	0	0	1	1	1	1
	MC <sub>5</sub>	T <sub>1</sub> T <sub>2</sub> T <sub>3</sub>	SP-2	PCL	1	0	0	1	1	1	1
$\overline{INT}$ ; MODE 0 (RST INSERTED)	MC <sub>1</sub>	T <sub>1</sub> T <sub>2</sub> T <sub>w</sub> T <sub>w</sub> T <sub>3</sub>	Next op-code Address (PC)	1st op-code	1	1	1	0	0	1	0
	MC <sub>2</sub> ~MC <sub>3</sub>	T <sub>1</sub> T <sub>1</sub>	.	Z	1	1	1	1	1	1	1
	MC <sub>4</sub>	T <sub>1</sub> T <sub>2</sub> T <sub>3</sub>	SP-1	PCH	1	0	0	1	1	1	1
	MC <sub>5</sub>	T <sub>1</sub> T <sub>2</sub> T <sub>3</sub>	SP-2	PCL	1	0	0	1	1	1	1
$\overline{INT}$ ; MODE 0 (CALL INSERTED)	MC <sub>1</sub>	T <sub>1</sub> T <sub>2</sub> T <sub>w</sub> T <sub>w</sub> T <sub>3</sub>	Next op-code Address (PC)	1st op-code	1	1	1	0	0	1	0
	MC <sub>2</sub>	T <sub>1</sub> T <sub>2</sub> T <sub>3</sub>	PC	n	0	1	0	1	1	1	1
	MC <sub>3</sub>	T <sub>1</sub> T <sub>2</sub> T <sub>3</sub>	PC+1	m	0	1	0	1	1	1	1
	MC <sub>4</sub>	T <sub>1</sub>	.	Z	1	1	1	1	1	1	1
	MC <sub>5</sub>	T <sub>1</sub> T <sub>2</sub> T <sub>3</sub>	SP-1	PC+2(H)	1	0	0	1	1	1	1
	MC <sub>6</sub>	T <sub>1</sub> T <sub>2</sub> T <sub>3</sub>	SP-2	PC+2(L)	1	0	0	1	1	1	1
$\overline{INT}$ ; MODE 1	MC <sub>1</sub>	T <sub>1</sub> T <sub>2</sub> T <sub>w</sub> T <sub>w</sub> T <sub>3</sub>	Next op-code Address (PC)		1	1	1	0	0	1	0
	MC <sub>2</sub>	T <sub>1</sub> T <sub>2</sub> T <sub>3</sub>	SP-1	PCH	1	0	0	1	1	1	1
	MC <sub>3</sub>	T <sub>1</sub> T <sub>2</sub> T <sub>3</sub>	SP-2	PCL	1	0	0	1	1	1	1
$\overline{INT}$ ; MODE 2	MC <sub>1</sub>	T <sub>1</sub> T <sub>2</sub> T <sub>w</sub> T <sub>w</sub> T <sub>3</sub>	Next op-code Address (PC)	Vector	1	1	1	0	0	1	0
	MC <sub>2</sub>	T <sub>1</sub>	.	Z	1	1	1	1	1	1	1
	MC <sub>3</sub>	T <sub>1</sub> T <sub>2</sub> T <sub>3</sub>	SP-1	PCH	1	0	0	1	1	1	1
	MC <sub>4</sub>	T <sub>1</sub> T <sub>2</sub> T <sub>3</sub>	SP-2	PCL	1	0	0	1	1	1	1
	MC <sub>5</sub>	T <sub>1</sub> T <sub>2</sub> T <sub>3</sub>	I, Vector	DATA	0	1	0	1	1	1	1
	MC <sub>6</sub>	T <sub>1</sub> T <sub>2</sub> T <sub>3</sub>	I, Vector+1	DATA	0	1	0	1	1	1	1

to be continued

Instruction	Machine Cycle	States	ADDRESS	DATA	$\overline{RD}$	$\overline{WR}$	$\overline{MREQ}$	$\overline{IORQ}$	$\overline{MT}$	$\overline{HALT}$	ST
INT <sub>1</sub> INT <sub>2</sub> Internal Interrupts	MC <sub>1</sub>	T <sub>1</sub> T <sub>2</sub> T <sub>w</sub> T <sub>w</sub> T <sub>3</sub>	Next op-code Address (PC)		1	1	1	1	1	1	0
	MC <sub>2</sub>	T <sub>i</sub>		Z	1	1	1	1	1	1	1
	MC <sub>3</sub>	T <sub>1</sub> T <sub>2</sub> T <sub>3</sub>	SP-1	PCH	1	0	0	1	1	1	1
	MC <sub>4</sub>	T <sub>1</sub> T <sub>2</sub> T <sub>3</sub>	SP-2	PCL	1	0	0	1	1	1	1
	MC <sub>5</sub>	T <sub>1</sub> T <sub>2</sub> T <sub>3</sub>	I. Vector	DATA	0	1	0	1	1	1	1
	MC <sub>6</sub>	T <sub>1</sub> T <sub>2</sub> T <sub>3</sub>	I. Vector+1	DATA	0	1	0	1	1	1	1



## E-1. Request Acceptances in Each Operating Mode

Request	Current Status	Normal Operation (CPU mode)	WAIT State	Refresh Cycle	Interrupt Acknowledge Cycle	DMA Cycle	BUS RELEASE mode	SLEEP mode	SYSTEM STOP mode
WAIT		Acceptable	Acceptable	Not acceptable	Acceptable	Acceptable	Not acceptable	Not acceptable	Not acceptable
Refresh Request (Request of Refresh by the on-chip Refresh Controller)		Refresh cycle begins at the end of MC.	Not acceptable	Not acceptable	Refresh cycle begins at the end of MC	Refresh cycle begins at the end of MC	Not acceptable	Not acceptable	Not acceptable
DREQ <sub>0</sub> DREQ <sub>1</sub>		DMA cycle begins at the end of MC.	DMA cycle begins at the end of MC.	Acceptable * Refresh cycle precedes DMA cycle begins at the end of one MC	Acceptable DMA cycle begins at the end of MC.	Acceptable Refer to "2.9 DMA Controller" for details	Acceptable * After BUS RELEASE cycle begins at the end of one MC	Not acceptable	Not acceptable
BUSREQ		Bus is released at the end of MC.	Not acceptable	Not acceptable	Bus is released at the end of MC	Bus is released at the end of MC	Continue BUS RELEASE mode.	Acceptable	Acceptable
Interrupt	INT <sub>0</sub> , INT <sub>1</sub> , INT <sub>2</sub>	Accepted after executing the current instruction.	Accepted after executing the current instruction.	Not acceptable	Not acceptable	Not acceptable	Not acceptable	Acceptable Return from SLEEP mode to normal operation.	Acceptable Return from SYSTEM STOP mode to normal operation.
	Internal I/O Interrupt								Not acceptable
	NMI				Not acceptable Interrupt acknowledge cycle precedes. NMI is accepted after executing the next instruction.	Acceptable DMA cycle stops			Acceptable Return from SYSTEM STOP mode to normal operation.

NOTE \* : not acceptable when DMA Request is in level sense.  
| : same as the above  
MC : Machine Cycle

## E-2. Request Priority

The Z80180 has the following three types of requests.

### Type 1.

To be accepted in specified state ..... WAIT

### Type 2.

To be accepted in each machine cycle..... Refresh Req.  
DMA Req.  
Bus Req.

### Type 3.

To be accepted in each instruction .. . . . . Interrupt Req.

Type 1, Type 2, and Type 3 requests priority is shown as follows.

highest priority Type 1 > Type 2 > Type 3 lowest priority

Each request priority in Type 2 is shown as follows.

highest priority Bus Req. > Refresh Req. > DMA Req.  
lowest priority

(NOTE) If Bus Req. and Refresh Req. occurs simultaneously, Bus Req. is accepted but Refresh Req. is cleared.



### E-3. Operation Mode Transition

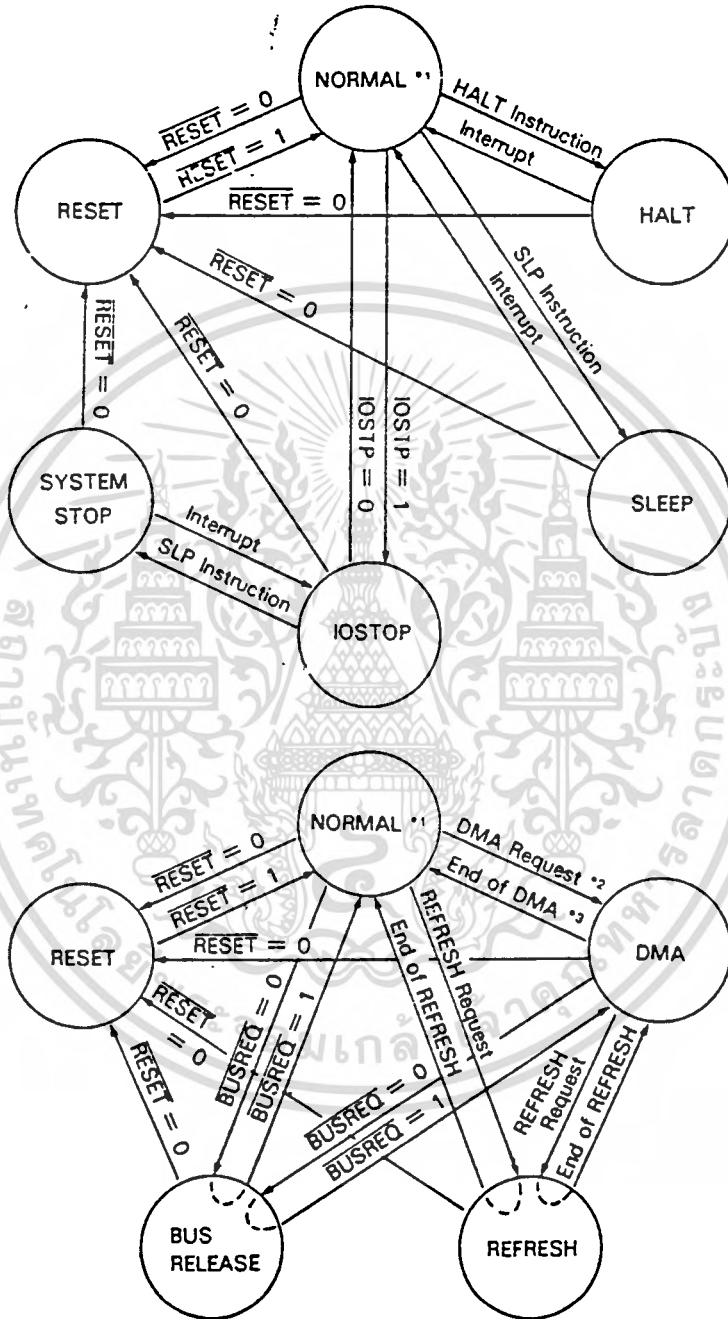

- NOTE
- \*1 NORMAL: CPU executes instructions normally in NORMAL mode.
  - \*2 DMA request: DMA is requested in the following cases.
    - (1)  $\overline{DREQ_0}, \overline{DREQ_1} = 0$  (memory to/from (memory mapped) I/O DMA transfer)
    - (2)  $DE0 = 1$  (memory to/from memory DMA transfer)
  - \*3 DMA end: DMA ends in the following cases.
    - (1)  $\overline{DREQ_0}, \overline{DREQ_1} = 1$  (memory to/from (memory mapped) I/O DMA transfer)
    - (2)  $BCR0, BCR1 = 0000H$  (all DMA transfers)
    - (3)  $NMI = 0$  (all DMA transfers)

#### Other operation mode transitions

The following operation mode transitions are also possible.

1. HALT  $\rightleftharpoons$ 
  - DMA
  - REFRESH
  - BUS RELEASE
- IOSTOP  $\rightleftharpoons$ 
  - DMA
  - REFRESH
  - BUS RELEASE
2. SLEEP  $\rightleftharpoons$  BUS RELEASE
- SYSTEM STOP  $\rightleftharpoons$  BUS RELEASE



## F-2. Pin Status during RESET and Low Power Operation Modes

Symbol	Pin function	Pin status in each operation mode			
		RESET	SLEEP	IOSTOP	SYSTEM STOP
WAIT	—	IN (N)	IN (N)	IN (A)	IN (N)
BUSACK	—	1	OUT	OUT	OUT
BUSREQ	—	IN (N)	IN (A)	IN (A)	IN (A)
RESET	—	0	IN (A)	IN (A)	IN (A)
NM	—	IN (N)	IN (A)	IN (A)	IN (A)
INT <sub>0</sub>	—	IN (N)	IN (A)	IN (A)	IN (A)
INT <sub>1</sub>	—	IN (N)	IN (A)	IN (A)	IN (A)
INT <sub>2</sub>	—	IN (N)	IN (A)	IN (A)	IN (A)
ST	—	1	1	OUT	1
A <sub>0</sub> ~A <sub>15</sub> , A <sub>16</sub>	—	Z	1	A	1
A <sub>17</sub> ~TOUT	A <sub>17</sub>	Z	1	A	1
	TOUT	Z	OUT	H	H
D <sub>0</sub> ~D <sub>7</sub>	—	Z	Z	A	Z
RTS <sub>0</sub>	—	1	H	OUT	H
CTS <sub>0</sub>	—	IN (N)	IN (A)	IN (N)	IN (N)
DCD <sub>0</sub>	—	IN (N)	IN (A)	IN (N)	IN (N)
TXA <sub>0</sub>	—	1	OUT	H	H
RXA <sub>0</sub>	—	IN (N)	IN (A)	IN (N)	IN (N)
CKA <sub>0</sub> DREQ <sub>0</sub>	CKA <sub>0</sub> (internal clock mode)	Z	OUT	Z	Z
	CKA <sub>0</sub> (external clock mode)	Z	IN (A)	IN (N)	IN (N)
	DREQ <sub>0</sub>	Z	IN (N)	IN (A)	IN (N)
TXA <sub>1</sub>	—	1	OUT	H	H
RXA <sub>1</sub>	—	IN (N)	IN (A)	IN (N)	IN (N)
CKA <sub>1</sub> TEND <sub>0</sub>	CKA <sub>1</sub> (internal clock mode)	Z	OUT	Z	Z
	CKA <sub>1</sub> (external clock mode)	Z	IN (A)	IN (N)	IN (N)
	TEND <sub>0</sub>	Z	1	OUT	1
TXS	—	1	OUT	H	H
RXS, CTS <sub>1</sub>	RXS	IN (N)	IN (A)	IN (N)	IN (N)
	CTS <sub>1</sub>	IN (N)	IN (A)	IN (N)	IN (N)
CKS	CKS (internal clock mode)	Z	OUT	1	1
	CKS (external clock mode)	Z	IN (A)	Z	Z
DREQ <sub>1</sub>	—	IN (N)	IN (N)	IN (A)	IN (N)
TEND <sub>1</sub>	—	1	1	OUT	1
HALT	—	1	0	OUT	0
RFSH	—	1	1	OUT	1
IORO	—	1	1	OUT	1
MREQ	—	1	1	OUT	1
E	—	0	E clock output	—	—
M1	—	1	1	OUT	1
WR	—	1	1	OUT	1
RD	—	1	1	OUT	1
φ	—	φ clock output	—	—	—

1: HIGH 0: LOW A: Programmable Z: High Impedance  
 IN (A): Input (Active) IN (N): Input (Not active) OUT: Output  
 H: Holds the previous state  
 —: same as the left

## G. Internal I/O Registers

By programming IOA7 and IOA6 in the I/O control register, internal I/O register addresses are relocatable within ranges from 0000H to 00FFH in the I/O address space.

REGISTER	MNEMONICS	ADDRESS	REMARKS																											
ASCI Control Register A Channel 0 : CNTLA0		0 0	<table border="1"> <thead> <tr> <th>bit</th> <th>MPE</th> <th>RE</th> <th>TE</th> <th>RTS0</th> <th>MPBR/ EFR</th> <th>MOD2</th> <th>MOD1</th> <th>MOD0</th> </tr> </thead> <tbody> <tr> <td>during RESET</td> <td>0</td> <td>0</td> <td>0</td> <td>1</td> <td>invalid</td> <td>0</td> <td>0</td> <td>0</td> </tr> <tr> <td>R/W</td> <td>R/W</td> <td>R/W</td> <td>R/W</td> <td>R/W</td> <td>R/W</td> <td>R/W</td> <td>R/W</td> <td>R/W</td> </tr> </tbody> </table> <p>                     MODE Selection                      Multi Processor Bit Receive/                      Error Flag Reset                      Request To Send                      Transmit Enable                      Receive Enable                      Multi Processor Enable                 </p>	bit	MPE	RE	TE	RTS0	MPBR/ EFR	MOD2	MOD1	MOD0	during RESET	0	0	0	1	invalid	0	0	0	R/W	R/W	R/W	R/W	R/W	R/W	R/W	R/W	R/W
bit	MPE	RE	TE	RTS0	MPBR/ EFR	MOD2	MOD1	MOD0																						
during RESET	0	0	0	1	invalid	0	0	0																						
R/W	R/W	R/W	R/W	R/W	R/W	R/W	R/W	R/W																						
ASCI Control Register A Channel 1 : CNTLA1		0 1	<table border="1"> <thead> <tr> <th>bit</th> <th>MPE</th> <th>RE</th> <th>TE</th> <th>CKA1D</th> <th>MPBR/ EFR</th> <th>MOD2</th> <th>MOD1</th> <th>MOD0</th> </tr> </thead> <tbody> <tr> <td>during RESET</td> <td>0</td> <td>0</td> <td>0</td> <td>1</td> <td>invalid</td> <td>0</td> <td>0</td> <td>0</td> </tr> <tr> <td>R/W</td> <td>R/W</td> <td>R/W</td> <td>R/W</td> <td>R/W</td> <td>R/W</td> <td>R/W</td> <td>R/W</td> <td>R/W</td> </tr> </tbody> </table> <p>                     MODE Selection                      Multi Processor Bit Receive/                      Error Flag Reset                      CKA1 Disable                      Transmit Enable                      Receive Enable                      Multi Processor Enable                 </p> <p>                     MOD2: 1, 0                      0 0 0 Start + 7 bit Data + 1 Stop                      0 0 1 Start + 7 bit Data + 2 Stop                      0 1 0 Start + 7 bit Data + Parity + 1 Stop                      0 1 1 Start + 7 bit Data + Parity + 2 Stop                      1 0 0 Start + 8 bit Data + 1 Stop                      1 0 1 Start + 8 bit Data + 2 Stop                      1 1 0 Start + 8 bit Data + Parity + 1 Stop                      1 1 1 Start + 8 bit Data + Parity + 2 Stop                 </p>	bit	MPE	RE	TE	CKA1D	MPBR/ EFR	MOD2	MOD1	MOD0	during RESET	0	0	0	1	invalid	0	0	0	R/W	R/W	R/W	R/W	R/W	R/W	R/W	R/W	R/W
bit	MPE	RE	TE	CKA1D	MPBR/ EFR	MOD2	MOD1	MOD0																						
during RESET	0	0	0	1	invalid	0	0	0																						
R/W	R/W	R/W	R/W	R/W	R/W	R/W	R/W	R/W																						
ASCI Control Register B Channel 0 : CNTLBO		0 2	<table border="1"> <thead> <tr> <th>bit</th> <th>MPBT</th> <th>MP</th> <th>CTS/ PS</th> <th>PEO</th> <th>DR</th> <th>SS2</th> <th>SS1</th> <th>SS0</th> </tr> </thead> <tbody> <tr> <td>during RESET</td> <td>invalid</td> <td>0</td> <td>.</td> <td>0</td> <td>0</td> <td>1</td> <td>1</td> <td>1</td> </tr> <tr> <td>R/W</td> <td>R/W</td> <td>R/W</td> <td>R/W</td> <td>R/W</td> <td>R/W</td> <td>R/W</td> <td>R/W</td> <td>R/W</td> </tr> </tbody> </table> <p>                     Clock Source and                      Speed Select                      Divide Ratio                      Parity Even or Odd                      Clear To Send/Prescale                      Multi Processor                      Multi Processor Bit Transmit                 </p> <p>                     • CTS . Depending on the condition of CTS Pin                      PS Cleared to 0.                 </p>	bit	MPBT	MP	CTS/ PS	PEO	DR	SS2	SS1	SS0	during RESET	invalid	0	.	0	0	1	1	1	R/W	R/W	R/W	R/W	R/W	R/W	R/W	R/W	R/W
bit	MPBT	MP	CTS/ PS	PEO	DR	SS2	SS1	SS0																						
during RESET	invalid	0	.	0	0	1	1	1																						
R/W	R/W	R/W	R/W	R/W	R/W	R/W	R/W	R/W																						

(to be continued)

REGISTER	MNEMONICS	ADDRESS	REMARKS																																																																													
ASCII Control Register B Channel 1 : CNTLB1		0 3	<table border="1"> <tr> <td>bit</td> <td>MPBT</td> <td>MP</td> <td>CTS/ PS</td> <td>PEO</td> <td>DR</td> <td>SS2</td> <td>SS1</td> <td>SS0</td> </tr> <tr> <td>during RESET</td> <td>invalid</td> <td>0</td> <td>0</td> <td>0</td> <td>0</td> <td>1</td> <td>1</td> <td>1</td> </tr> <tr> <td>R/W</td> <td>R/W</td> <td>R/W</td> <td>R/W</td> <td>R/W</td> <td>R/W</td> <td>R/W</td> <td>R/W</td> <td>R/W</td> </tr> </table> <p>           Clock Source and Speed Select            Divide Ratio            Parity Even or Odd            Clear To Send/Prescale            Multi Processor            Multi Processor Bit Transmit         </p> <table border="1"> <tr> <th>General divide ratio</th> <th colspan="2">PS=0 (divide ratio=10)</th> <th colspan="2">PS=1 (divide ratio=30)</th> </tr> <tr> <th>SS2,1,0</th> <th>DR=0 (x16)</th> <th>DR=1 (x64)</th> <th>DR=0 (x16)</th> <th>DR=1 (x64)</th> </tr> <tr> <td>000</td> <td><math>\phi + 160</math></td> <td><math>\phi + 640</math></td> <td><math>\phi + 480</math></td> <td><math>\phi + 1920</math></td> </tr> <tr> <td>001</td> <td>+ 320</td> <td>+ 1280</td> <td>+ 960</td> <td>+ 3840</td> </tr> <tr> <td>010</td> <td>+ 640</td> <td>+ 2560</td> <td>+ 1920</td> <td>+ 7680</td> </tr> <tr> <td>011</td> <td>+ 1280</td> <td>+ 5120</td> <td>+ 3840</td> <td>+ 15360</td> </tr> <tr> <td>100</td> <td>+ 2560</td> <td>+ 10240</td> <td>+ 7680</td> <td>+ 30720</td> </tr> <tr> <td>101</td> <td>+ 5120</td> <td>+ 20480</td> <td>+ 15360</td> <td>+ 61440</td> </tr> <tr> <td>110</td> <td>+ 10240</td> <td>+ 40960</td> <td>+ 30720</td> <td>+ 122880</td> </tr> <tr> <td>111</td> <td colspan="4">External clock (frequency &lt; <math>\phi + 40</math>)</td> </tr> </table>	bit	MPBT	MP	CTS/ PS	PEO	DR	SS2	SS1	SS0	during RESET	invalid	0	0	0	0	1	1	1	R/W	R/W	R/W	R/W	R/W	R/W	R/W	R/W	R/W	General divide ratio	PS=0 (divide ratio=10)		PS=1 (divide ratio=30)		SS2,1,0	DR=0 (x16)	DR=1 (x64)	DR=0 (x16)	DR=1 (x64)	000	$\phi + 160$	$\phi + 640$	$\phi + 480$	$\phi + 1920$	001	+ 320	+ 1280	+ 960	+ 3840	010	+ 640	+ 2560	+ 1920	+ 7680	011	+ 1280	+ 5120	+ 3840	+ 15360	100	+ 2560	+ 10240	+ 7680	+ 30720	101	+ 5120	+ 20480	+ 15360	+ 61440	110	+ 10240	+ 40960	+ 30720	+ 122880	111	External clock (frequency < $\phi + 40$ )			
bit	MPBT	MP	CTS/ PS	PEO	DR	SS2	SS1	SS0																																																																								
during RESET	invalid	0	0	0	0	1	1	1																																																																								
R/W	R/W	R/W	R/W	R/W	R/W	R/W	R/W	R/W																																																																								
General divide ratio	PS=0 (divide ratio=10)		PS=1 (divide ratio=30)																																																																													
SS2,1,0	DR=0 (x16)	DR=1 (x64)	DR=0 (x16)	DR=1 (x64)																																																																												
000	$\phi + 160$	$\phi + 640$	$\phi + 480$	$\phi + 1920$																																																																												
001	+ 320	+ 1280	+ 960	+ 3840																																																																												
010	+ 640	+ 2560	+ 1920	+ 7680																																																																												
011	+ 1280	+ 5120	+ 3840	+ 15360																																																																												
100	+ 2560	+ 10240	+ 7680	+ 30720																																																																												
101	+ 5120	+ 20480	+ 15360	+ 61440																																																																												
110	+ 10240	+ 40960	+ 30720	+ 122880																																																																												
111	External clock (frequency < $\phi + 40$ )																																																																															
ASCII Status Register Channel 0 : STAT0		0 4	<table border="1"> <tr> <td>bit</td> <td>RDRF</td> <td>OVRN</td> <td>PE</td> <td>FE</td> <td>RIE</td> <td>DCD<sub>0</sub></td> <td>TDRE</td> <td>TIE</td> </tr> <tr> <td>during RESET</td> <td>0</td> <td>0</td> <td>0</td> <td>0</td> <td>0</td> <td>-</td> <td>**</td> <td>0</td> </tr> <tr> <td>R/W</td> <td>R</td> <td>R</td> <td>R</td> <td>R</td> <td>R/W</td> <td>R</td> <td>R</td> <td>R/W</td> </tr> </table> <p>           Transmit Interrupt Enable            Transmit Data Register Empty            Data Carrier Detect            Receive Interrupt Enable            Framing Error            Parity Error            Over Run Error            Receive Data Register Full            CTS<sub>0</sub> Pin            TDRE            L 1            H 0         </p> <p>* DCD<sub>0</sub> : Depending on the condition of DCD<sub>0</sub> Pin.</p>	bit	RDRF	OVRN	PE	FE	RIE	DCD <sub>0</sub>	TDRE	TIE	during RESET	0	0	0	0	0	-	**	0	R/W	R	R	R	R	R/W	R	R	R/W																																																		
bit	RDRF	OVRN	PE	FE	RIE	DCD <sub>0</sub>	TDRE	TIE																																																																								
during RESET	0	0	0	0	0	-	**	0																																																																								
R/W	R	R	R	R	R/W	R	R	R/W																																																																								
ASCII Status Register Channel 1 : STAT1		0 5	<table border="1"> <tr> <td>bit</td> <td>RDRF</td> <td>OVRN</td> <td>PE</td> <td>FE</td> <td>RIE</td> <td>CTS1E</td> <td>TDRE</td> <td>TIE</td> </tr> <tr> <td>during RESET</td> <td>0</td> <td>0</td> <td>0</td> <td>0</td> <td>0</td> <td>0</td> <td>1</td> <td>0</td> </tr> <tr> <td>R/W</td> <td>R</td> <td>R</td> <td>R</td> <td>R</td> <td>R/W</td> <td>R/W</td> <td>R</td> <td>R/W</td> </tr> </table> <p>           Transmit Interrupt Enable            Transmit Data Register Empty            CTS1 Enable            Receive Interrupt Enable            Framing Error            Parity Error            Over Run Error            Receive Data Register Full         </p>	bit	RDRF	OVRN	PE	FE	RIE	CTS1E	TDRE	TIE	during RESET	0	0	0	0	0	0	1	0	R/W	R	R	R	R	R/W	R/W	R	R/W																																																		
bit	RDRF	OVRN	PE	FE	RIE	CTS1E	TDRE	TIE																																																																								
during RESET	0	0	0	0	0	0	1	0																																																																								
R/W	R	R	R	R	R/W	R/W	R	R/W																																																																								

to be continued

REGISTER	MNEMONICS	ADDRESS	REMARKS																																															
ASCI Transmit Data Register Channel 0	: TDHO	0 8																																																
ASCI Transmit Data Register Channel 1	: TDR1	0 7																																																
ASCI Receive Data Register Channel 0	: TSRO	0 8																																																
ASCI Receive Data Register Channel 1	: TSR1	0 9																																																
CS/O Control Register	: CNTR	0 A	<table border="1"> <thead> <tr> <th>bit</th> <th>EF</th> <th>EIE</th> <th>RE</th> <th>TE</th> <th>—</th> <th>SS2</th> <th>SS1</th> <th>SS0</th> </tr> </thead> <tbody> <tr> <td>during RESET</td> <td>0</td> <td>0</td> <td>0</td> <td>0</td> <td>1</td> <td>1</td> <td>1</td> <td>1</td> </tr> <tr> <td>R/W</td> <td>R</td> <td>R/W</td> <td>R/W</td> <td>R/W</td> <td></td> <td>R/W</td> <td>R/W</td> <td>R/W</td> </tr> </tbody> </table> <p>           End Flag            End Interrupt Enable            Receive Enable            Transmit Enable            Speed Select         </p> <table border="1"> <thead> <tr> <th>SS2,1,0</th> <th>Baud Rate</th> <th>SS2,1,0</th> <th>Baud Rate</th> </tr> </thead> <tbody> <tr> <td>000</td> <td>÷ + 20</td> <td>100</td> <td>÷ + 320</td> </tr> <tr> <td>001</td> <td>+ 40</td> <td>101</td> <td>+ 640</td> </tr> <tr> <td>010</td> <td>+ 80</td> <td>110</td> <td>+ 1280</td> </tr> <tr> <td>011</td> <td>+ 160</td> <td>111</td> <td>External (frequency &lt; + 20)</td> </tr> </tbody> </table>	bit	EF	EIE	RE	TE	—	SS2	SS1	SS0	during RESET	0	0	0	0	1	1	1	1	R/W	R	R/W	R/W	R/W		R/W	R/W	R/W	SS2,1,0	Baud Rate	SS2,1,0	Baud Rate	000	÷ + 20	100	÷ + 320	001	+ 40	101	+ 640	010	+ 80	110	+ 1280	011	+ 160	111	External (frequency < + 20)
bit	EF	EIE	RE	TE	—	SS2	SS1	SS0																																										
during RESET	0	0	0	0	1	1	1	1																																										
R/W	R	R/W	R/W	R/W		R/W	R/W	R/W																																										
SS2,1,0	Baud Rate	SS2,1,0	Baud Rate																																															
000	÷ + 20	100	÷ + 320																																															
001	+ 40	101	+ 640																																															
010	+ 80	110	+ 1280																																															
011	+ 160	111	External (frequency < + 20)																																															
CS/O Transmit/Receive Data Register	: TRDR	0 B																																																
Timer Data Register Channel OL	: TMDROL	0 C																																																
Timer Data Register Channel OH	: TMDROH	0 D																																																
Timer Reload Register Channel OL	: RLDROL	0 E																																																
Timer Reload Register Channel OH	: RLDROH	0 F																																																
Timer Control Register	: TCR	1 0	<table border="1"> <thead> <tr> <th>bit</th> <th>TIF1</th> <th>TIFO</th> <th>TIE1</th> <th>TIE0</th> <th>TOC1</th> <th>TOCO</th> <th>TDE1</th> <th>TDE0</th> </tr> </thead> <tbody> <tr> <td>during RESET</td> <td>0</td> <td>0</td> <td>0</td> <td>0</td> <td>0</td> <td>0</td> <td>0</td> <td>0</td> </tr> <tr> <td>R/W</td> <td>R</td> <td>R</td> <td>R/W</td> <td>R/W</td> <td>R/W</td> <td>R/W</td> <td>R/W</td> <td>R/W</td> </tr> </tbody> </table> <p>           Timer Interrupt Flag 1,0            Timer Interrupt Enable 1,0            Timer Output Control 1,0            Timer Down Count Enable 1,0         </p> <table border="1"> <thead> <tr> <th>TOC1,0</th> <th>A./TOUT</th> </tr> </thead> <tbody> <tr> <td>00</td> <td>Inhibited</td> </tr> <tr> <td>01</td> <td>Toggle</td> </tr> <tr> <td>10</td> <td>0</td> </tr> <tr> <td>11</td> <td>1</td> </tr> </tbody> </table>	bit	TIF1	TIFO	TIE1	TIE0	TOC1	TOCO	TDE1	TDE0	during RESET	0	0	0	0	0	0	0	0	R/W	R	R	R/W	R/W	R/W	R/W	R/W	R/W	TOC1,0	A./TOUT	00	Inhibited	01	Toggle	10	0	11	1										
bit	TIF1	TIFO	TIE1	TIE0	TOC1	TOCO	TDE1	TDE0																																										
during RESET	0	0	0	0	0	0	0	0																																										
R/W	R	R	R/W	R/W	R/W	R/W	R/W	R/W																																										
TOC1,0	A./TOUT																																																	
00	Inhibited																																																	
01	Toggle																																																	
10	0																																																	
11	1																																																	

to be continued

เอกสารนี้เป็นเอกสารที่สงวนไว้สำหรับการใช้งานที่ 218 ศึกษาเท่านั้น ไม่อนุญาตให้นำไปใช้ประโยชน์ด้านการค้า  
ไม่ว่ากรณีใดๆทั้งสิ้น อีกทั้งห้ามมิให้ตัดแปลงเนื้อหา และต้องอ้างอิงถึงเจ้าของเอกสารทุกครั้งที่มีการนำไปใช้

REGISTER	MNEMONICS	ADDRESS	REMARKS																									
Timer Data Register Channel 1L : TMDR1L		1 4																										
Timer Data Register Channel 1H : TMDR1H		1 5																										
Timer Reload Register Channel 1L : RLDR1L		1 6																										
Timer Reload Register Channel 1H : RLDR1H		1 7																										
Free Running Counter : FRC		1 8	read only																									
DMA Source Address Register Channel 0L : SAR0L		2 0																										
DMA Source Address Register Channel 0H : SAR0H		2 1																										
DMA Source Address Register Channel 0B : SAR0B		2 2	Bits 0-2 (3) are used for SAR0B. <table border="1"> <thead> <tr> <th>A<sub>16</sub></th> <th>A<sub>15</sub></th> <th>A<sub>17</sub></th> <th>A<sub>18</sub></th> <th>DMA Transfer Request</th> </tr> </thead> <tbody> <tr> <td>X</td> <td>X</td> <td>0</td> <td>0</td> <td>DREQ<sub>0</sub> (external)</td> </tr> <tr> <td>X</td> <td>X</td> <td>0</td> <td>1</td> <td>RDR0 (ASCII0)</td> </tr> <tr> <td>X</td> <td>X</td> <td>1</td> <td>0</td> <td>RDR1 (ASCII1)</td> </tr> <tr> <td>X</td> <td>X</td> <td>1</td> <td>1</td> <td>Not Used</td> </tr> </tbody> </table>	A <sub>16</sub>	A <sub>15</sub>	A <sub>17</sub>	A <sub>18</sub>	DMA Transfer Request	X	X	0	0	DREQ <sub>0</sub> (external)	X	X	0	1	RDR0 (ASCII0)	X	X	1	0	RDR1 (ASCII1)	X	X	1	1	Not Used
A <sub>16</sub>	A <sub>15</sub>	A <sub>17</sub>	A <sub>18</sub>	DMA Transfer Request																								
X	X	0	0	DREQ <sub>0</sub> (external)																								
X	X	0	1	RDR0 (ASCII0)																								
X	X	1	0	RDR1 (ASCII1)																								
X	X	1	1	Not Used																								
DMA Destination Address Register Channel 0L : DAR0L		2 3																										
DMA Destination Address Register Channel 0H : DAR0H		2 4																										
DMA Destination Address Register Channel 0B : DAR0B		2 5	Bits 0-2 (3) are used for DAR0B. <table border="1"> <thead> <tr> <th>A<sub>16</sub></th> <th>A<sub>15</sub></th> <th>A<sub>17</sub></th> <th>A<sub>18</sub></th> <th>DMA Transfer Request</th> </tr> </thead> <tbody> <tr> <td>X</td> <td>X</td> <td>0</td> <td>0</td> <td>DREQ<sub>0</sub> (external)</td> </tr> <tr> <td>X</td> <td>X</td> <td>0</td> <td>1</td> <td>TDR0 (ASCII0)</td> </tr> <tr> <td>X</td> <td>X</td> <td>1</td> <td>0</td> <td>TDR1 (ASCII1)</td> </tr> <tr> <td>X</td> <td>X</td> <td>1</td> <td>1</td> <td>Not Used</td> </tr> </tbody> </table>	A <sub>16</sub>	A <sub>15</sub>	A <sub>17</sub>	A <sub>18</sub>	DMA Transfer Request	X	X	0	0	DREQ <sub>0</sub> (external)	X	X	0	1	TDR0 (ASCII0)	X	X	1	0	TDR1 (ASCII1)	X	X	1	1	Not Used
A <sub>16</sub>	A <sub>15</sub>	A <sub>17</sub>	A <sub>18</sub>	DMA Transfer Request																								
X	X	0	0	DREQ <sub>0</sub> (external)																								
X	X	0	1	TDR0 (ASCII0)																								
X	X	1	0	TDR1 (ASCII1)																								
X	X	1	1	Not Used																								
DMA Byte Count Register Channel 0L : BC0L		2 6																										
DMA Byte Count Register Channel 0H : BC0H		2 7																										
DMA Memory Address Register Channel 1L : MAR1L		2 8																										
DMA Memory Address Register Channel 1H : MAR1H		2 9																										
DMA Memory Address Register Channel 1B : MAR1B		2 A	Bits 0-2 (3) are used for MAR1B.																									
DMA I/O Address Register Channel 1L : IAR1L		2 B																										
DMA I/O Address Register Channel 1H : IAR1H		2 C																										

\* In the R1 and Z Mask, these DMAC registers are expanded from 4 bits to 3 bits in the package version of CP-68 and FP-80.

To be continued

REGISTER	MNEMONICS	ADDRESS	REMARKS																																																															
DMA Byte Count Register Channel 1L	: BCR1L	2 E																																																																
DMA Byte Count Register Channel 1H	: BCR1H	2 F																																																																
DMA Status Register	: DSTAT	3 0																																																																
			<table border="1"> <tr> <td>bit</td> <td>DE1</td> <td>DE0</td> <td>DWE1</td> <td>DWE0</td> <td>DE1</td> <td>DE0</td> <td>--</td> <td>DME</td> </tr> <tr> <td>during RESET</td> <td>0</td> <td>0</td> <td>1</td> <td>1</td> <td>0</td> <td>0</td> <td>1</td> <td>0</td> </tr> <tr> <td>R/W</td> <td>R/W</td> <td>R/W</td> <td>W</td> <td>W</td> <td>R/W</td> <td>R/W</td> <td></td> <td>R</td> </tr> </table> <p>           DMA Master Enable            DMA Interrupt Enable 1,0            DMA Enable Bit Write Enable 1,0            DMA Enable ch 1,0         </p>	bit	DE1	DE0	DWE1	DWE0	DE1	DE0	--	DME	during RESET	0	0	1	1	0	0	1	0	R/W	R/W	R/W	W	W	R/W	R/W		R																																				
bit	DE1	DE0	DWE1	DWE0	DE1	DE0	--	DME																																																										
during RESET	0	0	1	1	0	0	1	0																																																										
R/W	R/W	R/W	W	W	R/W	R/W		R																																																										
DMA Mode Register	: DMODE	3 1	<table border="1"> <tr> <td>bit</td> <td>--</td> <td>--</td> <td>DM1</td> <td>DM0</td> <td>SM1</td> <td>SM0</td> <td>MMOD</td> <td>--</td> </tr> <tr> <td>during RESET</td> <td>1</td> <td>1</td> <td>0</td> <td>0</td> <td>0</td> <td>0</td> <td>0</td> <td>1</td> </tr> <tr> <td>R/W</td> <td></td> <td></td> <td>R/W</td> <td>R/W</td> <td>R/W</td> <td>R/W</td> <td>R/W</td> <td></td> </tr> </table> <p>           Memory MODE Select            Ch 0 Source Mode 1,0            Ch 0 Destination Mode 1,0         </p> <table border="1"> <thead> <tr> <th>DM1, 0</th> <th>Destination</th> <th>Address</th> <th>SM1, 0</th> <th>Source</th> <th>Address</th> </tr> </thead> <tbody> <tr> <td>0 0</td> <td>M</td> <td>DARO+1</td> <td>0 0</td> <td>M</td> <td>SARO+1</td> </tr> <tr> <td>0 1</td> <td>M</td> <td>DARO-1</td> <td>0 1</td> <td>M</td> <td>SARO-1</td> </tr> <tr> <td>1 0</td> <td>M</td> <td>DARO fixed</td> <td>1 0</td> <td>M</td> <td>SARO fixed</td> </tr> <tr> <td>1 1</td> <td>VO</td> <td>DARO fixed</td> <td>1 1</td> <td>VO</td> <td>SARO fixed</td> </tr> </tbody> </table> <table border="1"> <thead> <tr> <th>MMOD</th> <th>Mode</th> </tr> </thead> <tbody> <tr> <td>0</td> <td>Cycle Steal Mode</td> </tr> <tr> <td>1</td> <td>Burst Mode</td> </tr> </tbody> </table>	bit	--	--	DM1	DM0	SM1	SM0	MMOD	--	during RESET	1	1	0	0	0	0	0	1	R/W			R/W	R/W	R/W	R/W	R/W		DM1, 0	Destination	Address	SM1, 0	Source	Address	0 0	M	DARO+1	0 0	M	SARO+1	0 1	M	DARO-1	0 1	M	SARO-1	1 0	M	DARO fixed	1 0	M	SARO fixed	1 1	VO	DARO fixed	1 1	VO	SARO fixed	MMOD	Mode	0	Cycle Steal Mode	1	Burst Mode
bit	--	--	DM1	DM0	SM1	SM0	MMOD	--																																																										
during RESET	1	1	0	0	0	0	0	1																																																										
R/W			R/W	R/W	R/W	R/W	R/W																																																											
DM1, 0	Destination	Address	SM1, 0	Source	Address																																																													
0 0	M	DARO+1	0 0	M	SARO+1																																																													
0 1	M	DARO-1	0 1	M	SARO-1																																																													
1 0	M	DARO fixed	1 0	M	SARO fixed																																																													
1 1	VO	DARO fixed	1 1	VO	SARO fixed																																																													
MMOD	Mode																																																																	
0	Cycle Steal Mode																																																																	
1	Burst Mode																																																																	

(to be continued)

REGISTER	MEMONICS	ADDRESS	REMARKS																																																																									
DMA/WAIT Control Register : DCNTL		3 2	<table border="1"> <tr> <td>bit</td> <td>MW11</td> <td>MW10</td> <td>MW1</td> <td>MW0</td> <td>DMS1</td> <td>DMS0</td> <td>DM1</td> <td>DM0</td> </tr> <tr> <td>during RESET</td> <td>1</td> <td>1</td> <td>1</td> <td>1</td> <td>0</td> <td>0</td> <td>0</td> <td>0</td> </tr> <tr> <td>R/W</td> <td>R/W</td> <td>R/W</td> <td>R/W</td> <td>R/W</td> <td>R/W</td> <td>R/W</td> <td>R/W</td> <td>R/W</td> </tr> </table> <p>           DMA Ch 1            I/O Memory            Mode Select            DREQ Select i = 1,0            I/O Wait Insertion            Memory Wait Insertion         </p> <table border="1"> <tr> <td>MW1,0</td> <td>The number of wait states</td> <td>MW1,0</td> <td>The number of wait states</td> </tr> <tr> <td>00</td> <td>0</td> <td>00</td> <td>0</td> </tr> <tr> <td>01</td> <td>1</td> <td>01</td> <td>2</td> </tr> <tr> <td>10</td> <td>2</td> <td>10</td> <td>3</td> </tr> <tr> <td>11</td> <td>3</td> <td>11</td> <td>4</td> </tr> </table> <table border="1"> <tr> <td>DMSi</td> <td>Sense</td> </tr> <tr> <td>1</td> <td>Edge sense</td> </tr> <tr> <td>0</td> <td>Level sense</td> </tr> </table> <table border="1"> <tr> <td>DM1,0</td> <td>Transfer Mode</td> <td>Address Increment</td> <td>Decrement</td> </tr> <tr> <td>00</td> <td>M-I/O</td> <td>MAR1+1</td> <td>IAR1 fixed</td> </tr> <tr> <td>01</td> <td>M-I/O</td> <td>MAR1-1</td> <td>IAR1 fixed</td> </tr> <tr> <td>10</td> <td>I/O-M</td> <td>IAR1 fixed</td> <td>MAR1+1</td> </tr> <tr> <td>11</td> <td>I/O-M</td> <td>IAR1 fixed</td> <td>MAR1-1</td> </tr> </table>	bit	MW11	MW10	MW1	MW0	DMS1	DMS0	DM1	DM0	during RESET	1	1	1	1	0	0	0	0	R/W	R/W	R/W	R/W	R/W	R/W	R/W	R/W	R/W	MW1,0	The number of wait states	MW1,0	The number of wait states	00	0	00	0	01	1	01	2	10	2	10	3	11	3	11	4	DMSi	Sense	1	Edge sense	0	Level sense	DM1,0	Transfer Mode	Address Increment	Decrement	00	M-I/O	MAR1+1	IAR1 fixed	01	M-I/O	MAR1-1	IAR1 fixed	10	I/O-M	IAR1 fixed	MAR1+1	11	I/O-M	IAR1 fixed	MAR1-1
bit	MW11	MW10	MW1	MW0	DMS1	DMS0	DM1	DM0																																																																				
during RESET	1	1	1	1	0	0	0	0																																																																				
R/W	R/W	R/W	R/W	R/W	R/W	R/W	R/W	R/W																																																																				
MW1,0	The number of wait states	MW1,0	The number of wait states																																																																									
00	0	00	0																																																																									
01	1	01	2																																																																									
10	2	10	3																																																																									
11	3	11	4																																																																									
DMSi	Sense																																																																											
1	Edge sense																																																																											
0	Level sense																																																																											
DM1,0	Transfer Mode	Address Increment	Decrement																																																																									
00	M-I/O	MAR1+1	IAR1 fixed																																																																									
01	M-I/O	MAR1-1	IAR1 fixed																																																																									
10	I/O-M	IAR1 fixed	MAR1+1																																																																									
11	I/O-M	IAR1 fixed	MAR1-1																																																																									
Interrupt Vector Low Register : IL		3 3	<table border="1"> <tr> <td>bit</td> <td>I7</td> <td>I6</td> <td>I5</td> <td>-</td> <td>-</td> <td>-</td> <td>-</td> <td>-</td> </tr> <tr> <td>during RESET</td> <td>0</td> <td>0</td> <td>0</td> <td>0</td> <td>0</td> <td>0</td> <td>0</td> <td>0</td> </tr> <tr> <td>R/W</td> <td>R/W</td> <td>R/W</td> <td>R/W</td> <td></td> <td></td> <td></td> <td></td> <td></td> </tr> </table> <p>Interrupt Vector Low</p>	bit	I7	I6	I5	-	-	-	-	-	during RESET	0	0	0	0	0	0	0	0	R/W	R/W	R/W	R/W																																																			
bit	I7	I6	I5	-	-	-	-	-																																																																				
during RESET	0	0	0	0	0	0	0	0																																																																				
R/W	R/W	R/W	R/W																																																																									
INT/TRAP Control Register : ITC		3 4	<table border="1"> <tr> <td>bit</td> <td>TRAP</td> <td>UFO</td> <td>-</td> <td>-</td> <td>-</td> <td>ITE2</td> <td>ITE1</td> <td>ITE0</td> </tr> <tr> <td>during RESET</td> <td>0</td> <td>0</td> <td>1</td> <td>1</td> <td>1</td> <td>0</td> <td>0</td> <td>1</td> </tr> <tr> <td>R/W</td> <td>R/W</td> <td>R</td> <td></td> <td></td> <td></td> <td>R/W</td> <td>R/W</td> <td>R/W</td> </tr> </table> <p>           TRAP            Undefined Fetch Object            INT Enable 2,1,0         </p>	bit	TRAP	UFO	-	-	-	ITE2	ITE1	ITE0	during RESET	0	0	1	1	1	0	0	1	R/W	R/W	R				R/W	R/W	R/W																																														
bit	TRAP	UFO	-	-	-	ITE2	ITE1	ITE0																																																																				
during RESET	0	0	1	1	1	0	0	1																																																																				
R/W	R/W	R				R/W	R/W	R/W																																																																				
Refresh Control Register : RCR		3 6	<table border="1"> <tr> <td>bit</td> <td>REFE</td> <td>REFW</td> <td>-</td> <td>-</td> <td>-</td> <td>-</td> <td>CYC1</td> <td>CYC0</td> </tr> <tr> <td>during RESET</td> <td>1</td> <td>1</td> <td>1</td> <td>1</td> <td>1</td> <td>1</td> <td>0</td> <td>0</td> </tr> <tr> <td>R/W</td> <td>R/W</td> <td>R/W</td> <td></td> <td></td> <td></td> <td></td> <td>R/W</td> <td>R/W</td> </tr> </table> <p>           Refresh Wait State            Refresh Enable            Cycle Select         </p> <table border="1"> <tr> <td>CYC1,0</td> <td>Interval of Refresh Cycle</td> </tr> <tr> <td>00</td> <td>10 States</td> </tr> <tr> <td>01</td> <td>20</td> </tr> <tr> <td>10</td> <td>40</td> </tr> <tr> <td>11</td> <td>80</td> </tr> </table>	bit	REFE	REFW	-	-	-	-	CYC1	CYC0	during RESET	1	1	1	1	1	1	0	0	R/W	R/W	R/W					R/W	R/W	CYC1,0	Interval of Refresh Cycle	00	10 States	01	20	10	40	11	80																																				
bit	REFE	REFW	-	-	-	-	CYC1	CYC0																																																																				
during RESET	1	1	1	1	1	1	0	0																																																																				
R/W	R/W	R/W					R/W	R/W																																																																				
CYC1,0	Interval of Refresh Cycle																																																																											
00	10 States																																																																											
01	20																																																																											
10	40																																																																											
11	80																																																																											

(to be continued)

REGISTER	MNEMONICS	ADDRESS	REMARKS																											
MMU Common Base Register	: CBR	3 8	<table border="1"> <tr> <td>bit</td> <td>CB7*</td> <td>CB6</td> <td>CB5</td> <td>CB4</td> <td>CB3</td> <td>CB2</td> <td>CB1</td> <td>CB0</td> </tr> <tr> <td>during RESET</td> <td>0</td> <td>0</td> <td>0</td> <td>0</td> <td>0</td> <td>0</td> <td>0</td> <td>0</td> </tr> <tr> <td>R/W</td> <td>R/W</td> <td>R/W</td> <td>R/W</td> <td>R/W</td> <td>R/W</td> <td>R/W</td> <td>R/W</td> <td>R/W</td> </tr> </table> <p style="text-align: center;">MMU Common Base Register</p>	bit	CB7*	CB6	CB5	CB4	CB3	CB2	CB1	CB0	during RESET	0	0	0	0	0	0	0	0	R/W	R/W	R/W	R/W	R/W	R/W	R/W	R/W	R/W
bit	CB7*	CB6	CB5	CB4	CB3	CB2	CB1	CB0																						
during RESET	0	0	0	0	0	0	0	0																						
R/W	R/W	R/W	R/W	R/W	R/W	R/W	R/W	R/W																						
MMU Bank Base Register	: BBR	3 9	<table border="1"> <tr> <td>bit</td> <td>BB7*</td> <td>BB6</td> <td>BB5</td> <td>BB4</td> <td>BB3</td> <td>BB2</td> <td>BB1</td> <td>BB0</td> </tr> <tr> <td>during RESET</td> <td>0</td> <td>0</td> <td>0</td> <td>0</td> <td>0</td> <td>0</td> <td>0</td> <td>0</td> </tr> <tr> <td>R/W</td> <td>R/W</td> <td>R/W</td> <td>R/W</td> <td>R/W</td> <td>R/W</td> <td>R/W</td> <td>R/W</td> <td>R/W</td> </tr> </table> <p style="text-align: center;">MMU Bank Base Register</p>	bit	BB7*	BB6	BB5	BB4	BB3	BB2	BB1	BB0	during RESET	0	0	0	0	0	0	0	0	R/W	R/W	R/W	R/W	R/W	R/W	R/W	R/W	R/W
bit	BB7*	BB6	BB5	BB4	BB3	BB2	BB1	BB0																						
during RESET	0	0	0	0	0	0	0	0																						
R/W	R/W	R/W	R/W	R/W	R/W	R/W	R/W	R/W																						
MMU Common/Bank Area Register	: CBAR	3 A	<table border="1"> <tr> <td>bit</td> <td>CA3</td> <td>CA2</td> <td>CA1</td> <td>CA0</td> <td>BA3</td> <td>BA2</td> <td>BA1</td> <td>BA0</td> </tr> <tr> <td>during RESET</td> <td>1</td> <td>1</td> <td>1</td> <td>1</td> <td>0</td> <td>0</td> <td>0</td> <td>0</td> </tr> <tr> <td>R/W</td> <td>R/W</td> <td>R/W</td> <td>R/W</td> <td>R/W</td> <td>R/W</td> <td>R/W</td> <td>R/W</td> <td>R/W</td> </tr> </table> <p style="text-align: center;">MMU Common Area Register</p> <p style="text-align: right;">MMU Bank Area Register</p>	bit	CA3	CA2	CA1	CA0	BA3	BA2	BA1	BA0	during RESET	1	1	1	1	0	0	0	0	R/W	R/W	R/W	R/W	R/W	R/W	R/W	R/W	R/W
bit	CA3	CA2	CA1	CA0	BA3	BA2	BA1	BA0																						
during RESET	1	1	1	1	0	0	0	0																						
R/W	R/W	R/W	R/W	R/W	R/W	R/W	R/W	R/W																						
Operation Mode Control Register	OMCR	3 E	<table border="1"> <tr> <td>bit</td> <td>LIRE</td> <td>LIRTE</td> <td>IOC</td> <td>-</td> <td>-</td> <td>-</td> <td>-</td> <td>-</td> </tr> <tr> <td>during RESET</td> <td>1</td> <td>1</td> <td>1</td> <td>1</td> <td>1</td> <td>1</td> <td>1</td> <td>1</td> </tr> <tr> <td>R/W</td> <td>R/W</td> <td>W</td> <td>R/W</td> <td></td> <td></td> <td></td> <td></td> <td></td> </tr> </table> <p style="text-align: center;">LIR enable</p> <p style="text-align: center;">LIR Temporary Enable</p> <p style="text-align: center;">I/O Compatibility</p>	bit	LIRE	LIRTE	IOC	-	-	-	-	-	during RESET	1	1	1	1	1	1	1	1	R/W	R/W	W	R/W					
bit	LIRE	LIRTE	IOC	-	-	-	-	-																						
during RESET	1	1	1	1	1	1	1	1																						
R/W	R/W	W	R/W																											
I/O Control Register	: ICR	3 F	<table border="1"> <tr> <td>bit</td> <td>IOA7</td> <td>IOA6</td> <td>IOSTP</td> <td>-</td> <td>-</td> <td>-</td> <td>-</td> <td>-</td> </tr> <tr> <td>during RESET</td> <td>0</td> <td>0</td> <td>0</td> <td>1</td> <td>1</td> <td>1</td> <td>1</td> <td>1</td> </tr> <tr> <td>R/W</td> <td>R/W</td> <td>R/W</td> <td>R/W</td> <td></td> <td></td> <td></td> <td></td> <td></td> </tr> </table> <p style="text-align: center;">I/O Address</p> <p style="text-align: center;">I/O Stop</p>	bit	IOA7	IOA6	IOSTP	-	-	-	-	-	during RESET	0	0	0	1	1	1	1	1	R/W	R/W	R/W	R/W					
bit	IOA7	IOA6	IOSTP	-	-	-	-	-																						
during RESET	0	0	0	1	1	1	1	1																						
R/W	R/W	R/W	R/W																											

These MMU registers are expanded from 7 bits to 8 bits in the PLCC package

เอกสารนี้เป็นเอกสารที่สงวนไว้สำหรับการใช้งานที่ 222 ศึกษาเท่านั้น ไม่อนุญาตให้นำไปใช้ประโยชน์ด้านการค้า  
ไม่ว่ากรณีใดๆทั้งสิ้น อีกทั้งห้ามมิให้ดัดแปลงเนื้อหา และต้องอ้างอิงถึงเจ้าของเอกสารทุกครั้งที่มีการนำไปใช้

## ORDERING INFORMATION

### Codes

#### PACKAGE

P = Plastic Dip

V = Plastic Chip Carrier

#### TEMPERATURE

S = 0 C to +70 C

#### SPEED

06 = 6MHz

08 = 8MHz

10 = 10MHz

#### ENVIRONMENTAL

C = Plastic Standard

#### Example:

Z8018008PSC is an 80180 8 MHz, Plastic DIP, 0 C to 70 C, Plastic Standard Flow.

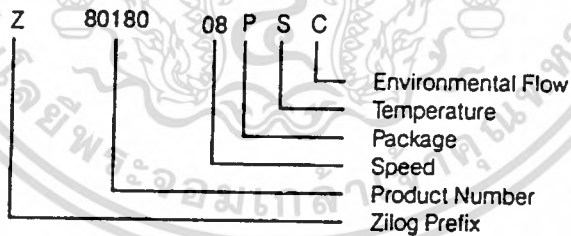





## โครงสร้างภายใน

หน่วยประมวลผลกลาง (Central Processing Unit) คอมแพคทีเบิ้ลกับ Z80 พร้อมเพิ่มชุดคำสั่งอีก 12 คำสั่ง

Clock Generator เป็นตัวสร้างสัญญาณนาฬิกาสำหรับระบบจากคริสตอล หรือจะต่อสัญญาณนาฬิกาจากภายนอกก็ได้โดยจะถูกหาร 2 แล้วได้ความถี่เป็นสัญญาณนาฬิกาของระบบ ( ซึ่งสามารถใช้คริสตอลความถี่ 20 เมกกะเฮิร์ตซ์จะได้ความถี่นาฬิกาของระบบ 10 เมกกะเฮิร์ตซ์ )

Bus-State-Controller ใช้ควบคุมบัส, CPU, และชิพสนับสนุนบางตัว และที่ส่วนนี้ยังรวม Wait State Timing, ระบบ Reset, DRAM, Refresh และการเปลี่ยนบัสของ DMA และยังให้สัญญาณในการ interface ให้ใช้กับอุปกรณ์ในตระกูล 68XX และ 80XX ให้เป็นไปได้ง่ายอีกด้วย

Interrupt Controller เป็นตัวจัดระดับความสำคัญของ Interrupt ให้มีความถูกต้อง

Memory Management Unit เป็นส่วนที่ใช้ทำการขยายหน่วยความจำหลัก จากเดิม 64 กิโลไบต์ ให้สูงถึง 1 เมกกะไบต์ โดยใช้เทคนิคแบ่งหน่วยความจำ ออกเป็นช่วงๆ ละ 64 กิโลไบต์ เป็น common area และ bank area จากนั้น MMU จะคำนวณหาแอดเดรสที่ใช้งานจริง เหตุที่ต้องแบ่งหน่วยความจำออกเป็นช่วงๆ เพื่อที่จะได้ใช้คำสั่งของ Z80 ได้

Direct Memory Access Controller (DMAC) มี 2 แชนแนล ใช้ส่งถ่ายข้อมูลด้วยความเร็วสูง โดยหน่วยความจำอ้างได้ถึง 1 เมกกะไบต์ และ อินพุต/เอาต์พุตได้ 64 กิโลไบต์ โดยการส่งถ่ายข้อมูลจะกระทำเป็นบล็อก ๆ ละ 64 กิโลไบต์

โดยจะเป็น memory-memory, memory-I/O, memory-memory I/O map, I/O-I/O ก็ได้

Asynchronous Serial Communication Interface (ASCI) มี 2 แชนแนลซึ่งเป็น full duplex UARTS แต่ละแชนแนล สามารถโปรแกรมการ กำหนด baud rate ได้ มีสัญญาณควบคุมโมเด็ม (MODEM) และยังสามารถใช้รูปแบบการติดต่อสื่อสารแบบไมโครโปรเซสเซอร์ร่วมได้อีกด้วย

Clock Serial I/O Port (CSIO) เป็นซิงโครนัสอินพุต/เอาต์พุตพอร์ต (synchronous I/O port) แบบ half-duplex โดยใช้สำหรับติดต่อสื่อสารกับ ไมโครคอมพิวเตอร์อื่นด้วยความเร็วสูง

Programmable Reload Timer (PRT) มี 2 แชนแนล โดยแต่ละ แชนแนล จะมี timer count 16 bit และ 16 bit reload โดยเวลาการ ไหว้วาทกรรมใดๆทั้งสิ้น อีกทั้งห้ามมิให้ตัดแปลงเนื้อหา และต้องอ้างอิงถึงเจ้าของเอกสารทุกครั้งที่มีการนำไปใช้

นับแต่ละครั้ง เมื่อสัญญาณนาฬิกาครบ 20 ลูก จึงจะนับลงหนึ่ง และที่แชนเนลที่ 1 ยังสามารถให้สัญญาณเอาต์พุตที่เป็น wave form ได้อีกด้วย

## ขาการใช้งาน

AO-A19 ADDRESS BUS ระหว่างรีเซตจะเป็น high impedance ส่วน A18 จะมัลติเพล็กซ์กับเอาต์พุตของ PRT CHANNEL 1 ส่วน A19 จะมีเฉพาะชิพแบบ PLCC

$\overline{\text{BUSACK}}$  BUS ACKNOWLEDGE เป็นขาเอาต์พุตแอกทีฟ "0" ทำงานก็ต่อเมื่อ Z80180 ตอบสนองต่อการขอติดต่อบัสของ  $\overline{\text{BUSRD}}$  และทำให้บัสข้อมูล, บัสแอดเดรส, และสัญญาณควบคุมบางเส้นเป็น high impedance

$\overline{\text{BUSRD}}$  BUS REQUEST เป็นขาอินพุตแอกทีฟ "0" ซึ่งมีความสำคัญสูงกว่า NMI โดยจะมีการตรวจสอบสัญญาณขึ้นทุกๆการสิ้นสุดของแมชชีนไซเคิล (machine cycle)

CKA0,CKA1 ASYNCHRONOUS CLOCK 0 และ 1 เป็นขาสัญญาณนาฬิกาแบบ 2 ทิศทาง คือจะให้ เป็นขาอินพุตหรือเอาต์พุตก็ได้

CKS SERIAL CLOCK เป็นขาสัญญาณนาฬิกา 2 ทิศทางของ CS I/O CLOCK เป็นขาเอาต์พุต โดยจะเป็นครึ่งหนึ่งของ XTAL หรือ CLOCK INPUT

DO-D7 DATA BUS เป็นแบบ 2 ทิศทาง (อินพุต/เอาต์พุต)

$\overline{\text{DCDO}}$  DATA CARRIER DETECTOR เป็นขาอินพุต แอกทีฟ "0" ใช้ควบคุมในการติดต่อกับโมเด็มของ ASCI CHANNEL 0

$\overline{\text{DREQ0}}, \overline{\text{DREQ1}}$  DMA REQUEST 0 และ 1 เป็นขาอินพุต แอกทีฟ "0" ใช้ในการขอ DMA และที่ขานี้จะโปรแกรมได้ให้ตรวจสอบสัญญาณที่ขอบพัลส์ หรือระดับลอจิกได้

ENABLE CLOCK เป็นขาเอาต์พุต แอกทีฟ "1" ซึ่งใช้ซิงค์การทำงานกับอุปกรณ์ภายนอกระหว่างการทำเกี่ยวกับบัส

$\overline{\text{HALT}}$  เป็นขาเอาต์พุต แอกทีฟ "0" ทำงานเมื่อทำคำสั่ง HALT หรือ SLP

$\overline{\text{INT0}}$  MASKABLE INTERRUPT 0 เป็นขาอินพุต แอกทีฟ "0" สัญญาณที่ขานี้จะถูกตรวจทุกๆการสิ้นสุดของคำสั่ง

$\overline{\text{INT1}}, \overline{\text{INT2}}$  เช่นเดียวกับ INT0 แต่ระดับความสำคัญรองลงมาตามลำดับ

$\overline{\text{IORQ}}$  เป็นขาเอาต์พุตเพื่อบอกว่า กำลังติดต่อกับ I/O หรือขา IOE ใน 64180

เอกสารนี้เป็นเอกสารที่ลิขสิทธิ์ของ MITS MACHINE CYCLE 1 เป็นขาเอาต์พุต สัญญาณแอกทีฟ "0" โดยจะทำงานไม่ว่ากรณีใดๆทั้งสิ้น อีกทั้งห้ามมิให้ดัดแปลงเนื้อหา และต้องอ้างอิงถึงเจ้าของเอกสารทุกครั้งที่มีการนำไปใช้

เมื่อ fetch opcode หรือเป็นขา  $\overline{LIR}$  ของ 64180

$\overline{NMI}$  NON MASKABLE INTERRUPT เป็นขาอินพุต แยกที่ฟ "0" ขานี้จะ  
ตอบรับการอินเทอร์รัพต์เสมอ โดยไม่สามารถหยุดด้วยซอฟต์แวร์

RD เป็นขาที่ใช้ทำการอ่านข้อมูลจากหน่วยความจำหรือ I/O

$\overline{RFSH}$  เป็นขาที่ให้ ADDRESS LOW (A0-A7) ไปรีเฟรชไดนามิกแรมหรือ  
ขา  $\overline{REF}$  ของ 64180

$\overline{RTSO}$  REQUEST TO SEND เป็นขาเอาต์พุต แยกที่ฟ "0" ขานี้ใช้  
โปรแกรมสัญญาณควบคุมโมเด็มของ ASCII CHANNEL0

RXAO, RXA1 RECEIVE DATA 0 และ 1 เป็นขารับสัญญาณจากพอร์ต  
อนุกรมของ ASCII

RXS CLOCK SERIAL RECEIVE DATA เป็นขารับสัญญาณแบบอนุกรม  
ของ CSIO

ST STATUS เป็นขาเอาต์พุต แยกที่ฟ "1" ใช้แสดงสถานะการทำงาน  
ของซีพียู โดยร่วมกับ  $\overline{M1}$  และ  $\overline{HALT}$  ดังตารางที่ 1

$\overline{TENDO}$ ,  $\overline{TEND1}$  TRANSFER END 0 และ 1 เป็นขาเอาต์พุต แยกที่ฟ  
"0" ใช้แสดงถึงว่าได้ทำ DMA ลีนส์ดลงแล้ว

TOUT TIMER OUT ใช้กำเนิดพัลส์จาก PRT CHANNEL 1

TXAO, TXA1 TRANSMIT DATA 0 และ 1 เป็นขาส่งข้อมูลแบบอนุกรม  
ของ ASCII

TXS CLOCK SERIAL TRANSMIT DATA เป็นขาส่งข้อมูลแบบอนุกรม  
ของ CSIO

WAIT ขาอินพุตแยกที่ฟ "0" จะถูกตรวจที่ขอบขาของสัญญาณนาฬิกา  
ลูกที่ 2 ของแมชชีนไซเคิล เพื่อเป็นการรอให้อุปกรณ์ภายนอกทำงานให้ทันกับการ  
ทำงานของซีพียู

$\overline{WR}$  ใช้สำหรับการส่งข้อมูลไปยังอินพุต/เอาต์พุต หรือหน่วยความจำ

X'TAL เป็นขาใช้ต่อกับ X'TAL ขาที่ทำงานแบบมัลติเพิล็กซ์

A18 /  $\overline{TOUT}$  ระหว่างรีเซตจะเป็น A18 แต่ถ้ามีการเลือกเซตบิต TOC1  
หรือ TOC0 ใน TIMER CONTROL REGISTER (TCR) ก็จะทำหน้าที่เป็น TOUT

CKAO/ $\overline{DREQ0}$  ระหว่างรีเซตขานี้จะเป็น CKAO แต่ถ้า DM 1 หรือ SM 1  
ใน DMA MODE REGISTER (DMODE) ถูกเซตเป็น 1  $\overline{DREQ0}$  จะถูกเลือก

CKA1/ $\overline{TENDO}$  ระหว่างรีเซตขานี้จะเป็น CKA1 ถ้าบิต CKA10 ใน ASCII  
CHANNEL1 (CNTLA1) ถูกเซตเป็น 1  $\overline{TENDO}$  จะถูกเลือก

เอกสารนี้เป็นเอกสารลิขสิทธิ์ของมหาวิทยาลัยเทคโนโลยีพระจอมเกล้าธนบุรี  
RXS/ $\overline{CTS1E}$  ระหว่างรีเซตขานี้จะเป็น RXS ถ้าบิต CTS1E ใน ASCII

ไม่ว่ากรณีใดๆทั้งสิ้น อีกทั้งห้ามมิให้คัดแปลงเนื้อหา และต้องอ้างอิงถึงเจ้าของเอกสารทุกครั้งที่มีการนำไปใช้

CHANNEL1 (STAT1) ถูกเซตเป็น 1 ขานี้จะเป็น  $\overline{CTS1}$

ตารางที่ 1 แสดงสถานะการทำงานของซีพียู Z80180

ST	HALT	M1	การทำงาน
0	1	0	CPU ทำการ FETCH OP CODE1 ครั้ง
1	1	0	CPU ทำการ FETCH OP CODE2 และ 3 ครั้ง
1	1	1	CPU ทำ FETCH OP CODE แต่ไม่ทำ MC
0	X	1	ทำ DMA
0	0	0	HALT
1	0	1	SLEEP MODE รวมถึง SYSTEM STOP ด้วย

### โหมดการทำงาน

Z80180 สามารถกำหนดการทำงานให้เหมือน 64180 ได้ โดยการเซตบิต control ขณะอยู่ใน MODE CONTROL REGISTER (OMCR)

M1 E. (M1 Enable) ระหว่างรีเซต บิตนี้จะเป็น 1 เอาต์พุต  $\overline{M1}$  จะเป็น "0" เมื่อรับคำสั่ง และเนื่องจากการทำคำสั่ง RETI ของ Z80180 จะถูกกระทำ 2 ครั้ง ใน 1 คำสั่ง จึงทำให้เกิด  $\overline{M1}$  ขึ้น 2 ครั้ง อันอาจเกิดสัญญาณอินเตอร์รัพต์เข้ามาได้เมื่อยังทำไม่หมดคำสั่ง ด้วยเหตุนี้บิต M1E จะถูกเซตเป็น 0 สำหรับ Z80180 เพื่อให้  $\overline{M1}$  ทำงานปกติ คือเมื่อทำคำสั่ง RETI จะมี  $\overline{M1}$  เพียงครั้งเดียว

$\overline{M1TE}$  (M1 Temporary Enable) ใช้กับการติดต่ออุปกรณ์ภายนอก เช่น ใช้กับ Z80PIO

$\overline{IOC}$  เป็นบิตใช้ควบคุม TIMING ของ  $\overline{IORQ}$  และ  $\overline{RD}$  ให้เหมือน Z80 หรือ 64180 โดยถ้าบิตนี้เป็น 1 จะเป็นของ 64180 คือ  $\overline{IORQ}$  และ  $\overline{RD}$  จะแยกทิมที่ขอบขาลงของ T1 แต่ถ้าเป็น 0 จะเป็นเหมือน Z80 คือจะแยกทิมที่ขอบขาขึ้นของ T2 เพื่อให้ใช้อุปกรณ์สนับสนุนของ Z80 ได้ง่ายระหว่างรีเซตบิตนี้จะเป็น 1

### คำสั่งเพิ่มเติมใน Z80180

Z80180 นอกจากจะใช้ชุดคำสั่งเดียวกันกับ Z80 เดิมได้แล้ว ยังได้เพิ่มเติมชุดคำสั่งขึ้นมา 12 คำสั่งด้วยกัน โดยมีรายละเอียดดังต่อไปนี้

SLP เป็นคำสั่งให้ CPU หยุดทำคำสั่งและการทำงานบางอย่างเพื่อประหยัดค่า  
ไม่ว่ากรณีใดๆทั้งสิ้น อีกทั้งห้ามมิให้ดัดแปลงเนื้อหา และต้องอ้างอิงถึงเจ้าของเอกสารทุกครั้งที่มีการนำไปใช้

พลังงาน

MLT 8 บิต โดยที่รีจิสเตอร์คู่เป็นตัวตั้งและตัวคูณ ผลลัพธ์ ที่ได้ อยู่ที่รีจิสเตอร์คู่อื่นๆ

OTIM, OTIMR, OTDM, OTDMR ลักษณะการใช้งานเหมือนกับคำสั่ง OUTI, OTIR, OUTD, OTDR ของ Z80 โดยคำสั่งใหม่นี้จะทำการเพิ่ม หรือลดค่าพอร์ต ไปด้วย

TSTIO m สำหรับตรวจสอบพอร์ตโดยการรับค่าจากพอร์ต แล้วนำมา AND กับข้อมูลขนาด 8 บิต โดยข้อมูลของพอร์ตไม่เปลี่ยนแปลง ผลของคำสั่งทำให้ Flag เปลี่ยนแปลง

TST ๘ ใช้ตรวจสอบรีจิสเตอร์ คือจะนำค่าในรีจิสเตอร์ AND กับค่าใน แอคคิวมูเลเตอร์ (ACCUMULATOR) โดยที่ค่าทั้ง 2 ไม่เปลี่ยนแปลง แต่ Flag เปลี่ยนแปลง

TST m, TST (HL) การทำงานเหมือนกับคำสั่ง TST ๘ เพียงแต่ เปลี่ยนค่าจากรีจิสเตอร์เป็นข้อมูลโดยตรงและค่าข้อมูลใน HL

INO ๘, (m) หรือ OUTO (m), ๘ ใช้ในการรับหรือส่งข้อมูลกับพอร์ตที่กำหนดเบอร์ไว้มาเก็บไว้ในรีจิสเตอร์ใดก็ได้

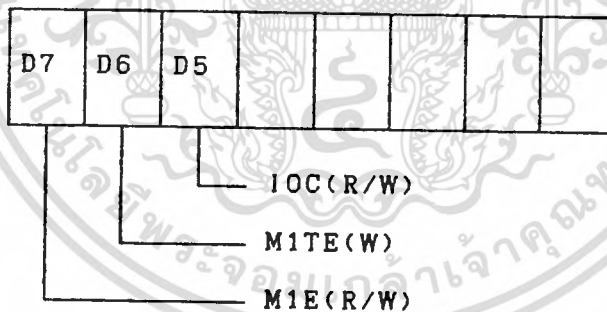
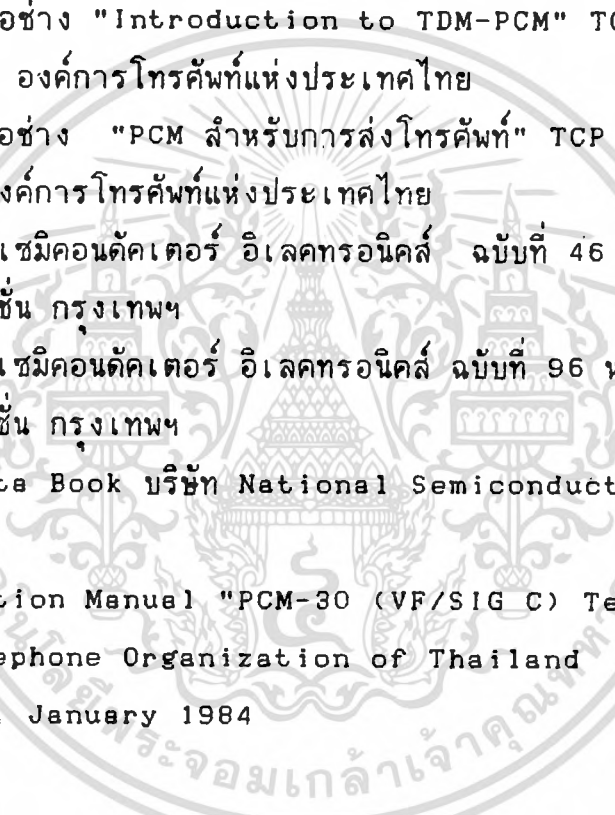

Fig 2 การเซตบิตเพื่อกำหนดโหมดในการทำงาน

## เอกสารอ้างอิง

- 
- [1] Instruction Manual Model 1053D, Direct Control ROTL/52A Responder, DIN 1000-0663-801, APC Industries Inc, USA
  - [2] หนังสือคู่มือช่าง "Crossbar ARF 102 Part 1" SW-56, ศูนย์ฝึกโทรคมนาคม องค์การโทรศัพท์แห่งประเทศไทย นนทบุรี
  - [3] หนังสือคู่มือช่าง "Basic Telephony & Principle of Exchange" TCP-537, ศูนย์ฝึกโทรคมนาคม องค์การโทรศัพท์แห่งประเทศไทย
  - [4] หนังสือคู่มือช่าง "Introduction to TDM-PCM" TCP 433, ศูนย์ฝึกโทรคมนาคม องค์การโทรศัพท์แห่งประเทศไทย
  - [5] หนังสือคู่มือช่าง "PCM สำหรับการส่งโทรศัพท์" TCP 426, ศูนย์ฝึกโทรคมนาคม องค์การโทรศัพท์แห่งประเทศไทย
  - [6] วารสาร เซมิคอนดักเตอร์ อิเล็กทรอนิกส์ ฉบับที่ 46 หน้า 97-101 บริษัท ซีเอ็ดยูเคชั่น กรุงเทพฯ
  - [7] วารสาร เซมิคอนดักเตอร์ อิเล็กทรอนิกส์ ฉบับที่ 96 หน้า 177-183 บริษัท ซีเอ็ดยูเคชั่น กรุงเทพฯ
  - [8] CMOS Data Book บริษัท National Semiconductor หน้า 2-184 ถึง 2-188
  - [9] Instruction Manual "PCM-30 (VF/SIG C) Terminal Equipment" for Telephone Organization of Thailand W-6/A-1 Project Issue 1, January 1984

เอกสารนี้เป็นเอกสารที่สงวนไว้สำหรับการใช้งานเพื่อการศึกษาเท่านั้น ไม่อนุญาตให้นำไปใช้ประโยชน์ด้านการค้า  
ไม่ว่ากรณีใดๆทั้งสิ้น อีกทั้งห้ามมิให้ตัดแปลงเนื้อหา และต้องอ้างอิงถึงเจ้าของเอกสารทุกครั้งที่มีการนำไปใช้